

**U2 Series Video Conference  
Camera Controller**

# **USER INSTRUCTION**

## **USE/INSTALLATION**

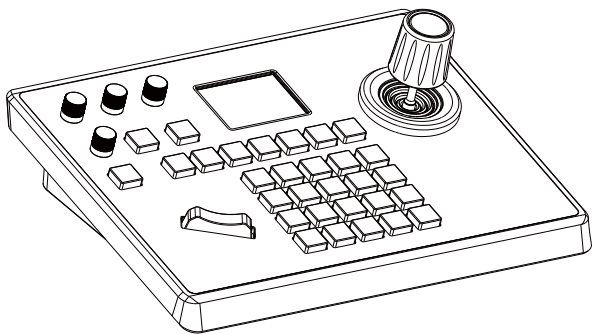

# Contents

<b>1. Product Overview</b> .....	<b>01</b>
1.1 Simple Description .....	01
1.2 Product Features .....	01
<b>2. Interface Description</b> .....	<b>01</b>
2.1 Interface Description .....	01
2.2 System expansion diagram .....	02
<b>3. Buttons Description</b> .....	<b>05</b>
3.1 Buttons Description .....	05
3.2 Joystick rotations description .....	07
<b>4. Add device</b> .....	<b>08</b>
4.1 Add network device .....	08
4.2 Add analog device .....	08
<b>5. Inquiry &amp; Control</b> .....	<b>09</b>
<b>6. Network configuration</b> .....	<b>09</b>
6.1 Homepage connection and login .....	09
6.2 Web network settings .....	11
6.3 System Upgrade .....	12
6.4 System reset .....	12
6.5 Restart .....	13
6.6 Import configuration .....	13
6.7 Export configuration .....	13
6.8 Version information .....	14
<b>7. FQA</b> .....	<b>14</b>

## **Preface**

Thank you for purchasing our products, please be free to contact us if you have any questions or requests. The purpose of this user manual is to ensure the users can use the product correctly to avoid danger or property damaged during operation. Before using this product, please refer to this user manual carefully and keep it for future reference.

## **State**

The content described in this manual may be different from the version you are using. If you have any questions when using this manual, please contact our technical support for help.

This manual will be updated from time to time and the company reserves the right to notify without notice.



# 1. Product Overview

## 1.1 Simple Description

The U2 keyboard adopts the new design of CNC aluminum panel fine sand oxidation upper shell and PC+ABS bottom shell, which has strong maneuverability and effectively solves the problem that the current web operation video conference camera is inconvenient. The high-end atmosphere, unique surface oxidation treatment, the appearance is simple and beautiful; the industrial-grade LCD screen module has excellent display effect and the characters are delicate and clear. It supports VISCA and ONVIF protocols, and the VISCA is fully compatible and extensible. The built-in web server makes the configuration interface simple and clear, and it is easy to operate. A few steps to achieve perfect control of the video conference camera.

## 1.2 Product Features

- (1) Support IP and analog two control mode. Enjoy independent IP address in network mode.
- (2) Support VISCA, Onvif, Pelco-D, Pelco-P protocol and VISCA is fully compatible.
- (3) Support control the software function of the conference camera, with the central control function.
- (4) Support 4D joystick, feeling comfortable and good.
- (5) Twisting the joystick can control the camera rotations and lens zoom in/zoom out directly. The speed of the control can be controlled according to the strength of the joystick control.
- (6) Using seesaw to control the camera zoom, which is convenient and powerful.
- (7) Support IE browser to add and configure front-end device parameters.
- (8) Up to 7 camera shortcut control buttons, operate the camera quickly, which greatly improving the speed of switching multiple cameras.
- (9) Support standard POE power supply.

# 2. Interface Description

## 2.1 Interface Description

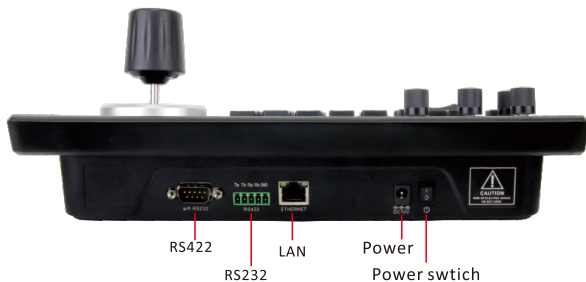

Number	Name	Function
1	Power switch	Power on/off
2	Power	Standard 5.5/2.1 power port,DC 12V2A±10%
3	LAN	Connect network
4	RS232	Support visca
5	RS422	Support pelco

## 2.2 System expansion diagram

### (1) Network connection

Network mode network VISCA, ONVIF control camera connection diagram

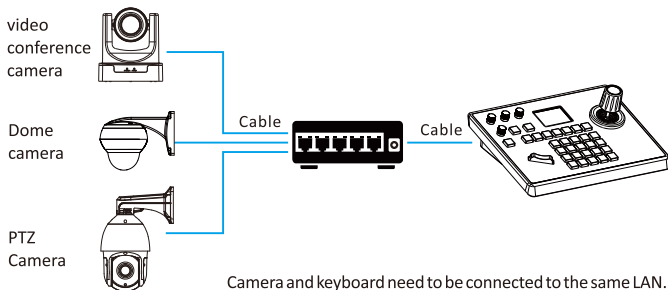

## (2) Analog mode RS485 control camera connection diagram.

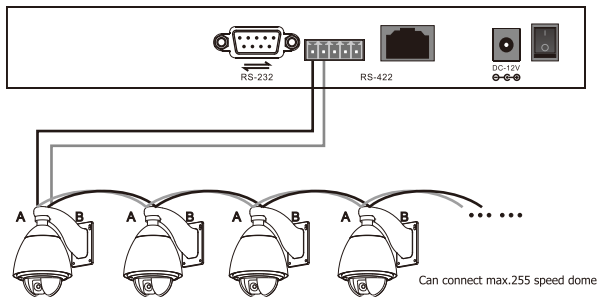

Control output:

The RS485+ of the camera is connected to Ta of the controller, and the RS485- of the camera is connected to the Tb of the controller.

## (3) Video conference connection method

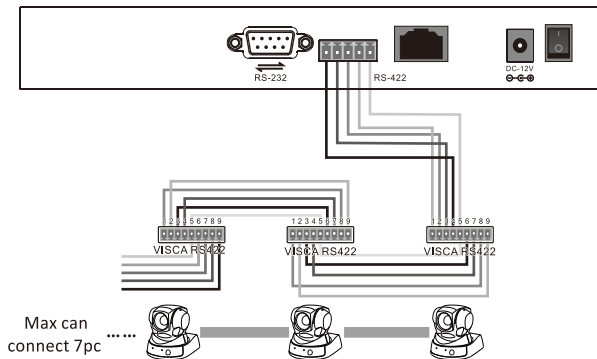

Using RS422 bus connection mode, the third pin Ra of the controller is connected to the TXD IN- of the camera, the fourth pin Rb of the controller is connected to the TXD IN+ of the camera, the first pin Ta of the controller is connected to the RXD IN- of the camera, the second pin Tb of the controller is connected to the RXD IN+ of the camera

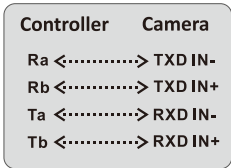

Using RS232 connection mode, the first pin RXD of the controller (10Pin terminal) is connected to the camera input interface TXD, the second pin TXD of the controller is connected to the camera RXD, and the third pin of the controller is connected to the camera GND (you can also use the standard RS232 interface DB0 of the controller to connect the camera).

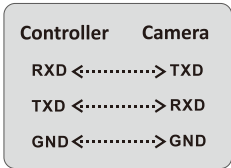

#### (4) Connection between cameras

Using RS422 bus cascade connection mode, the output of camera 1 is connected to the input of camera 2, the output of camera 2 is connected to the input of camera 3, and so on. As below :

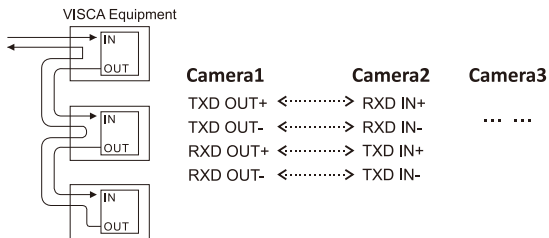

Using RS232 cascade connection mode almost the same as RS422. The output of camera 1 is connected to the input of camera 2, the output of camera 2 is connected to the input of camera 3, and so on.

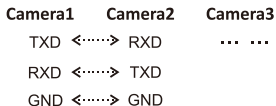



## 3. Buttons Description

### 3.1 Buttons Description

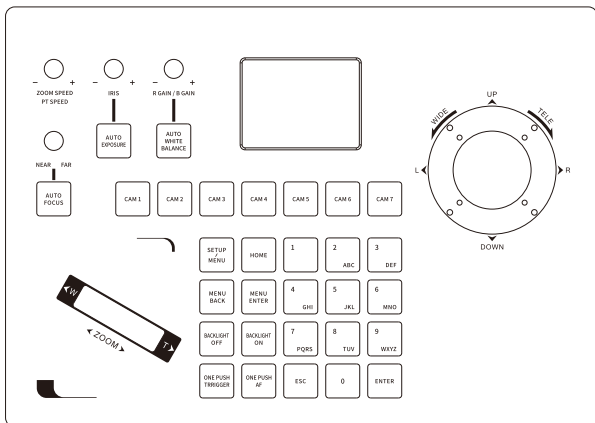

**(1) AUTO WHITE BALANCE:** Auto white balance

**(2) AUTO EXPOSURE:** Auto exposure

**(3) AUTO FOCUS:** Auto focus

**(4) SETUP/MENU:** Setup(short press)/ camera menu(long press)

**(5) MENU BACK:** camera menu back

**(6) MENU ENTER:** camera menu confirm

**(7) HOME:** camera back to the origin

**(8) CAM1-7:**

1.cameras ID quickly switch 2.each CAM enjoys IP mode and Analog mode.

**(9) BACKLIGHT ON/BACKLIGHT OFF:**

One key to turn on the backlight/ one key to turn off the backlight

**(10) ONE PUSH TRIGGER:** One key white balance

**(11) ONE PUSH AF:** One key auto focus

**(12) ESC:** Exit

**(13) ENTER:** Enter

**(14) 1-9:** Number key preset (long press to set preset) ( short press to call preset)

Controller setting	Description	
1.Add network device	Camera	The serial number of camera can be filled in 1-7; after adding camera all information press[ENTER] to save.
	Protocol	Optional:VISCA(UPD), SONY VISCA(UDP), VISCA(TCP), ONVIF, select the corresponded protocol of the camera
	IP address	Camera ip address
	Port	Input the camera port number
	User name & Password	Input the camera user name and password
2.Add analog device	Camera	The serial number of camera can be filled in 1-7, after adding camera all information press[ENTER] to save
	Protocol	Select the protocol corresponding to the camera
	Address code	Select the address code corresponding to the camera
	Baud rate	Select the baud rate corresponding to the camera
3.Device list	Added camera list can be switched through joystick up and down. Press the middle button on the top of the joystick nor press [ENTER] to confirm	
4.Network properties	Network properties	Switch through Joystick left and right,press[ENTER] to confirm
	Dynamic	Dynamic allocation based on switch settings
	Static	Need to fill in ip,gateway, subnet mask,keep to enjoy the same LAN as came
5. Device Language: EN/Chinese	Switch through Joystick left and right,press[ENTER] to confirm	
6. Key tone	Switch through Joystick left and right,press[ENTER] to confirm	
7. Reset	Double press[ENTER] to reset, press[ESC] to cancel	
8. System information	Check the controller software, hardware, Web version, gateway and subnet mask	

**[MENU BACK]** After setting the camera parameters,click this button to return to the previous level and then return to the main menu in increments.(for video conference ptz camera)

**[MENU ENTER]** Click the button to enter the menu confirmation for each item

**[BACKLIGHT ON]** Click the button to set the screen light brightness gain

**[BACKLIGHT OFF]** Click the button to set the screen light to enter the initial value display state

**[ONE PUSH TRIGGER]** One key white balance

**[ONE PUSH AF]** One key auto focus

**[0-9]:** Number key preset (long press to set preset) ( short press to call preset)

Set No. 1 preset:







Move the camera to the position where you want to set preset- Long press[1]

Call No.1 preset: short press[1]

**[ESC]:** Exit

**[ENTER]:** Confirm

### 3.2 Joystick rotations description

Operate	Output control	Operate	Output control	Operate	Output control
	Up		Down		Left
Operate	Output control	Operate	Output control	Operate	Output control
	Right		Zoom+		Zoom-

**(1) ZOOM SPEED/PT SPEED** zoom speed/control speed

turn the knob right+ while left-. Press the knob to switch the speed type.

**(2) IRIS** turn the knob right + while left-, Press the knob there is no function.

The related button on the left of the knob **AUTOEXPOSURE** is auto exposure.

**(3) RGAIN/BGAIN** Red/blue gain Turn the knob right + while left-. Press the knob to switch the gain type. The related button on the left of the knob **AUTO WHITE BALANCE** is auto white balance.

**(4) NAR/FAR** Focus Turn the knob right+ while left-. Press the knob there is no function.

The related button on the left of the knob **AUTOFOCUS** is auto focus function.

**(5) Joystick clockwise / counterclockwise:** zoom + zoom -.

**(6) Seesaw:** T zoom + W zoom -

## 4. Add device

### 4.1 Add network device

Use the controller to add LAN devices as follows:

(1) Click the controller "SETUP" to enter the main menu.

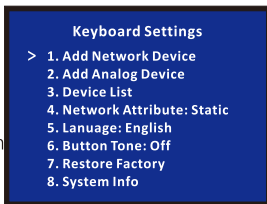

(2) Click Add Network Device, fill in the camera, protocol, IP address, port, correct username and password, and press **[ENTER]** to confirm



(3) Enter the device list, use the joystick up or down to select the device just added, press the middle button of the joystick or **[ENTER]** to control.



### 4.2 Add analog device

(1) Long press the middle button of joystick to switch the analog mode.

(2) Press SETUP button to enter the setting interface, select to add analog device.

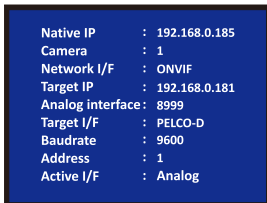

- (3) Enter the device adding interface, select the camera with 1-7 digital number, select the corresponding analog protocol, select the address code corresponding to the camera, select the baud rate, and press [ENTER] to confirm the addition.

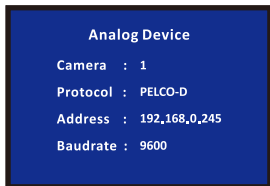

## 5. Inquiry & Control

- (1) On the main menu interface, press the "SETUP" button to enter the setting interface, move the joystick up and down to select the device list, press [ENTER] button to view the added device.

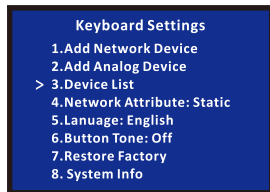

- (2) View the saved device through the joystick up and down, Press the middle button of the joystick or [ENTER] button to select the camera to be controlled.



- (3) When the screen shows that the connection is successful, it means that the controller has been connected to this IP device. At this time if the connection is successful, you can perform operations such as controlling the camera.

**Mark:** You can also exit the main interface of the controller system setting, and press the corresponding camera shortcut key on the keyboard to quickly connect and control the camera.

## 6. Network configuration

### 6.1 Homepage connection and login

Connect the power cable of the controller and connect the network cable. After keyboard start-up is complete, the device IP: 192.168.x.xxx will be displayed on the

display. Enter this IP address into the browser to access to configure the page. The initial user name: admin; password; empty.

(1) Connect the controller and computer in the same LAN,enter the controller address in the browser. The page displays as follows:

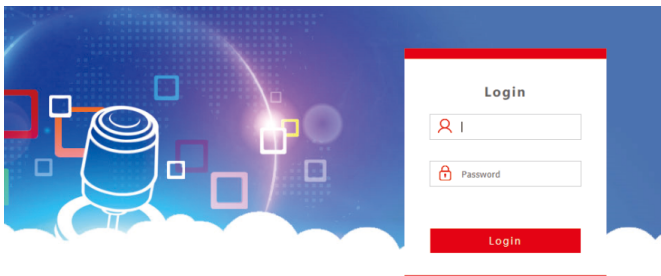

(2) default user name: admin password: empty (no password)

(3) Enter device web interface,the page displays as follows:



Camera	IP	Port	Protocol(network)	Baudrate	Address	Protocol(analog)	Operate
1	192.168.5.170	1259	VISCA(UDP)	9600	1	VISCA	
2	192.168.5.170	1259	VISCA(UDP)	9600	2	VISCA	
3	192.168.5.170	1259	VISCA(UDP)	9600	3	VISCA	
4	192.168.5.170	1259	VISCA(UDP)	9600	4	VISCA	
5	192.168.5.170	1259	VISCA(UDP)	9600	5	VISCA	
6	192.168.5.170	1259	VISCA(UDP)	9600	6	VISCA	

(4) After entering the homepage of the device, you can view the parameter details of the device, which can be changed.

(5) Click button to add and modify device parameters in the local area network, the page displays as follows:

**Edit**

**Camera** 1

**Network:**

Protocol ONVIF

IP 192.168.0.73

Port 80

Username root

Password pass

**Analog:**

Protocol VISCA

Baudrate 9600

Address 1

**Save**

Input the device number, corresponding IP address, port number and user name. Click Save.

Note: When entering the WEB interface of the controller to add the device successfully, it is synchronized with the controller. After adding the device successfully on the web page, click the number corresponding to the controller to control the camera.

## 6.2 Web network settings

LAN settings can modify the device's IP acquisition method and port parameters, as shown below:

**Device Management** **Settings**

**Network**

Network Type DHCP

IP Address 192.168.0.93

Netmask 255.255.254.0

Gateway 192.168.0.2

DNS1 8.8.8.8

DNS2 8.8.4.4

**Save**

Static address (STATIC): When the user needs to set the network segment by himself, the network type is modified to a static address, fill in the network segment information that needs to be modified.

Dynamic address (DHCP) (default acquisition method): The controller will automatically request an IP address from the router, after the request is successful it will be displayed on the display and the display format is: Then it can be displayed on the display of the keyboard, the display format is“Local IP: xxx.xxx.xxx.xxx”

### 6.3 System Upgrade

Upgrade function is used as maintenance and update controller function. Select the correct upgrade file after entering the upgrade pages and click “start” . After the upgrade is complete, the device will automatically restart.

**Note:** Do not perform any operation on the device during its upgrade, and do not power off or disconnect the network!

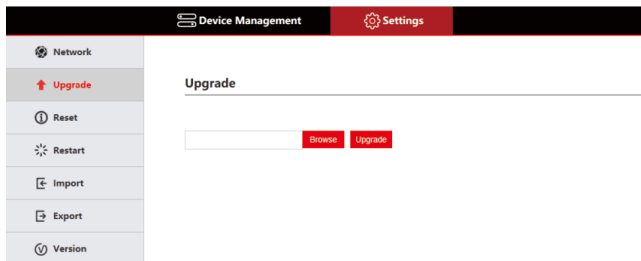

### 6.4 System reset

When the device is clicked to reset, the controller will clear all data, it is recommended to exercise caution!

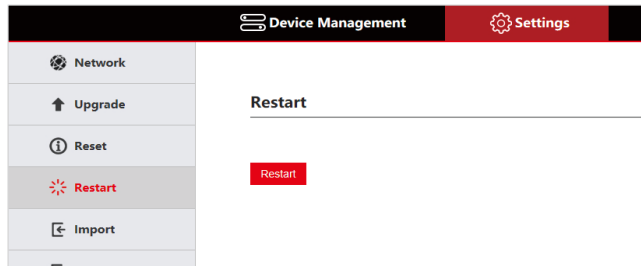



## 6.5 Restart

When the device is used for a long time and requires to be restarted for maintenance, click Restart to achieve the purpose of restarting maintenance.

## 6.6 Import configuration

Import the device information of the previous controller, (for example, when adding multiple devices to the previous controller, export the file type, and use it to import to another device when adding a new controller.)

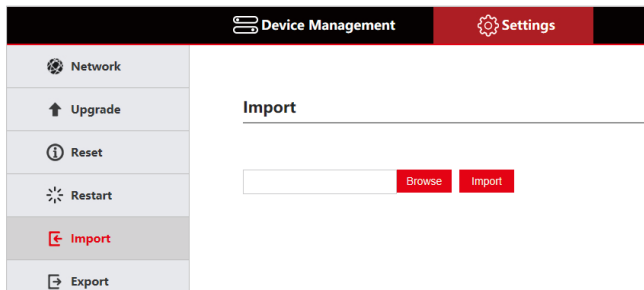

## 6.7 Export configuration

Export the related information of the current controller added multiple devices, which can be exported to other controller devices.

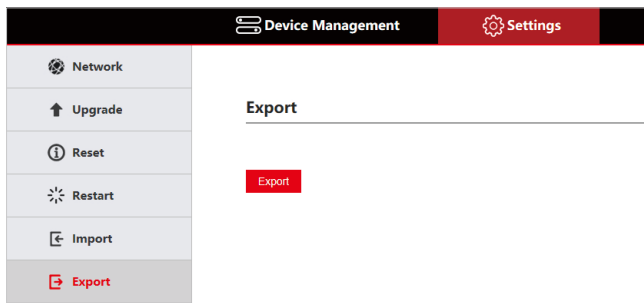

## 6.8 Version information

Display the software and hardware information of the current controller.

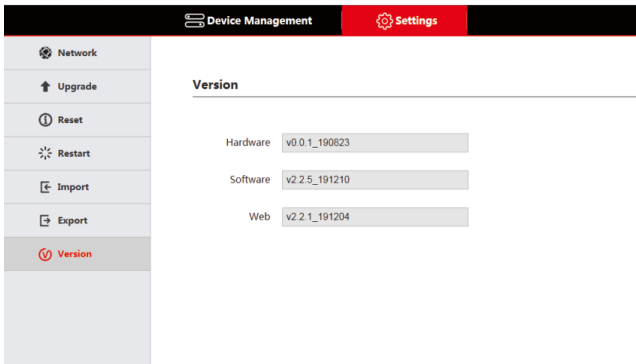

The screenshot shows a web interface for Device Management. At the top, there are two tabs: "Device Management" and "Settings". Below the tabs is a sidebar menu with the following options: Network, Upgrade, Reset, Restart, Import, Export, and Version (which is highlighted in red). The main content area is titled "Version" and displays the following information:

Hardware	v0.0.1_190823
Software	v2.2.5_191210
Web	v2.2.1_191204

## 7.FQA

1. When the screen displays "Connection failed", please check whether the device corresponding to this ip is connected normally in the LAN.
2. When the screen displays "User name and password are incorrect", please check whether the added device user name and password are correct.
3. When using onvif protocol to add other brands of devices fails, check whether the camera opens the device's ONVIF protocol.

Note:

- (1) The device is added manually.
- (2) Enter the correct port number and device connection protocol when add device.



