

IP&Serial Joystick Remote Control Keyboard

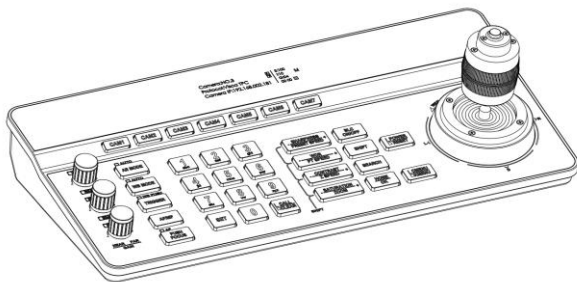

User Manual V1.2

J.BC.0205.0157

1. Security Guidance	2
1.1 Cautions.....	2
1.2 Notice.....	2
2. Check Before Using	3
2.1 Packing List.....	3
2.2 The Wiring.....	3
2.3 Bottom Dialing Switch.....	3
3. Keyboard Description	4
3.1 Functional Features.....	4
3.2 Technical Specifications.....	5
3.3 Product Size.....	5
3.4 Interface Description.....	6
3.5 Display Screen Content.....	6
3.6 Button Function.....	7
4. Menu Setting	11
4.1 Operating Instructions.....	11
4.2 Menu options.....	11
5. Wiring diagram	12
5.1 Connection in network mode.....	12
5.2 Connection in RS232 mode.....	13
5.3 Connection in RS422 mode.....	14
5.4 Connection in RS485 mode.....	14
5.5 Cascade in RS232, RS422, RS485 mode.....	15
6. WEB Configuration	17
6.1 Login WEB.....	17
6.2 Device Control.....	17
6.3 Network Paramete.....	18
6.4 Firmware Upgrade.....	18
6.5 Reset Options.....	18
6.6 Account.....	19
7. Frequently Asked Questions	20



1. Security Guidance



1.1 Cautions:

- Before using the product, please read this safety instruction carefully, operate strictly in accordance with the instruction manual, and keep this manual properly for future reference.
- The standard power supply voltage is DC 12V and the rated current is 1A. It is recommended to use with the power adapter that comes with the product.
- Please place the power cable and control cable in a place where they will not be trampled on, and protect the cable, especially the connection part must be firm.
- Please use this product within the allowable temperature and humidity range. Operating temperature: $-10^{\circ}\text{C} \sim 50^{\circ}\text{C}$, humidity $\leq 80\%$.
- Do not spill liquids, especially corrosive liquids, on this product to prevent danger.
- Please don't put heavy pressure, violent vibration and immersion during transportation, storage and installation to avoid damaging the product.
- Please do not disassemble this product without permission, there are no parts inside the machine that can be repaired by the user, please leave the work to qualified maintenance personnel.
- Power supply polarity:



1.2 Notice:

- Please refer to the actual product, the user manual is for reference only.
- Please contact our Customer Service Department for the latest procedures and additional documentation.
- In case of doubt or dispute in the user manual, the final interpretation of the company shall prevail.

■■■■■■■■ 2. Check Before Using ■■■■■■■■

2.1 Packing List

When opening the package, please check and confirm all the accessories that should be provided.

Control keyboard.....	1PCS
Power Adapter.....	1PCS
Power Cord.....	1PCS
RS232 Cord.....	1PCS
User Manual.....	1PCS
Certificate of Conformity.....	1PCS
Warranty Card.....	1PCS
Quick Guide.....	1PCS

2.2 The Wiring

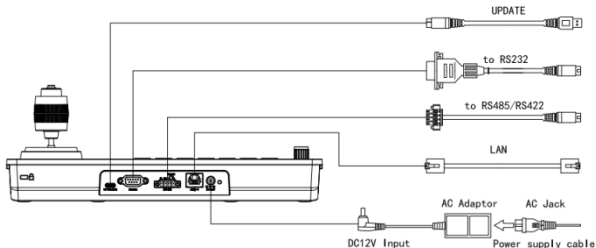

2.3 Bottom Dialing Switch

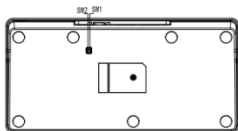

Bottom dial control			
Mode	SW-1	SW-2	Description
1	*	OFF	ARM Upgrade Mode
2	*	ON	Normal Working Mode
SW-1 is reserved, no function defined			

==== 3. Keyboard Description ====

3.1 Functional Features:

- ★ Support network interface, RS232 interface, RS422 interface and RS485 interface for control.

- ★ Supports VISCA Serial, Pelco-P, Pelco-D, VISCA over IP, VISCA TCP, VISCA UDP, ONVIF, and NDI protocols for control. (NDI protocol is optional.)

- ★ With seven camera shortcut control buttons, to improve the speed of multiple cameras control switching, convenient and fast.

- ★ Support setting different protocols to control multiple cameras with different protocols.

- ★ Support one keyboard to control multiple cameras, also support multiple keyboards to control a camera through the network interface.

- ★ Adapts four-dimensional joystick to enable the control of the video camera PTZ movement smoothly and flexibly.

- ★ Support to set different levels of operation permission via OSD menu.

- ★ Support button keys backlight, enable users to choose automatic backlight in low light or dark environment.

- ★ Support set, call and clear presets.

- ★ Support camera PT speed and zoom speed adjustment, while supporting preset position PT speed and zoom speed adjustment.

- ★ Support daisy chain function. (Max 7 cameras are available)

- ★ Support camera OSD menu setting.

- ★ Supports standard POE (Power Over Ethre).

- ★ Support 10M, 100M adaptive network RJ45 connection.

- ★ Support both Chinese and English menu interface.

▬▬▬▬▬ 3. Keyboard Description ▬▬▬▬▬

3.2 Technical Specifications:

Parameters	Indicators
Control Interface	RJ45,RS232,RS422,RS485
RJ45	Ethernet port, POE (IEEE802.3af)
RS232	DB9 male connector
RS422	3.81 spacing terminal, T+, T-, R+, R-
RS485	3.81 spacing terminal, T+, T-
Support Protocols	VISCA Serial, Pelco-P, Pelco-D, VISCA over IP, VISCA TCP, VISCA UDP, ONVIF, NDI(optional)
Upgrade Interface	Type-C
Display Screen	3.12" OLED screen, blue light, 256×64 pixels
Working power	12V=1A
Working Temperature	-10°C~50°C
Working Humidity	≤80%
Storage Temperature	-20°C~60°C
Storage Humidity	≤90%
Size	320.5mm×156.5mm×118mm
Weight	1.05kg

3.3 Product Size:

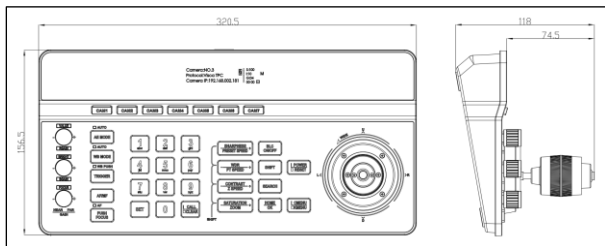

▄▄▄▄▄ 3. Keyboard Description ▄▄▄▄▄

3.4 Interface Description:

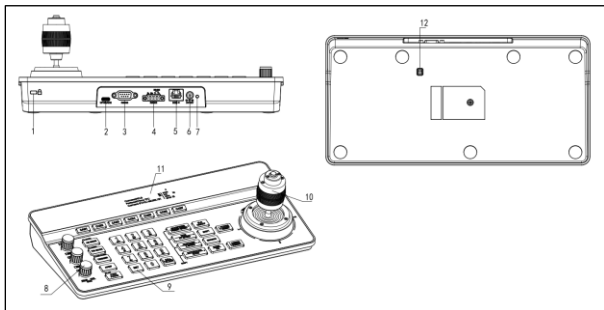

- | | | |
|----------------------|----------------------|--------------------|
| 1. Lock hole | 5. Network interface | 9. Button |
| 2. Upgrade interface | 6. Power interface | 10. Joystick |
| 3. RS232 interface | 7. Indicator light | 11. Display screen |
| 4. RS485 interface | 8. Adjusting knob | 12. Dial switch |

3.5 Display Screen Content:

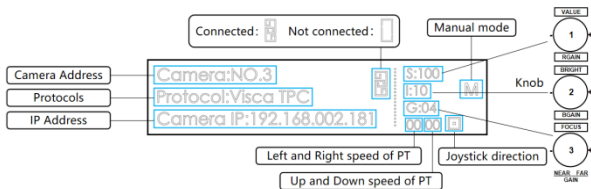

▄▄▄▄▄ 3. Keyboard Description ▄▄▄▄▄

3.6 Button Function

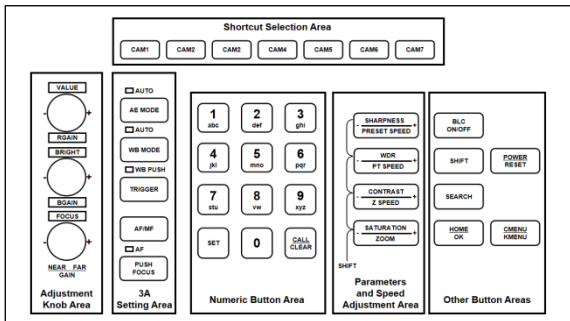

3.6.1 Shortcut Selection Area

【CAM1】 ~ 【CAM7】 Select the corresponding camera.

3.6.2 Adjustment Knob Area, 3A Setting Area

【AE MODE】 There is the word "AUTO" next to the button **AE MODE**. When the "AUTO" light is on, automatic exposure mode is triggered; when the "AUTO" light is OFF, the other modes manual exposure, shutter priority, iris priority, bright priority can be selected, and at this time, the three knobs on the left side of the keyboard can adjust the shutter, iris, gain, bright and other parameters.

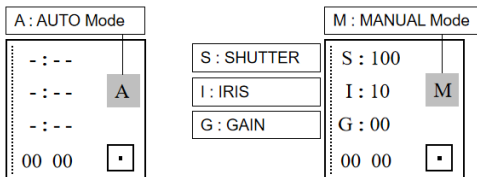

3. Keyboard Description

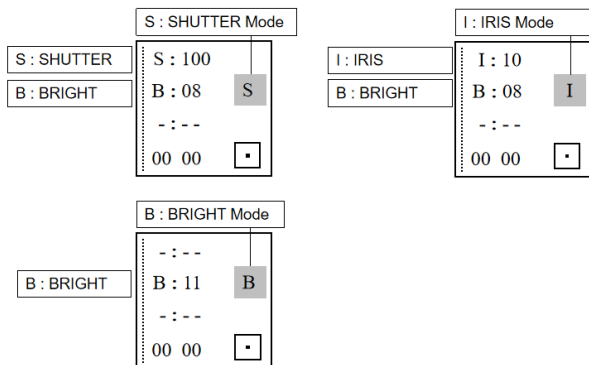

【WB MODE】 There is the word "AUTO" next to the button **WB MODE**. when the "AUTO" light is on, it is AUTO and ATW mode; when the "AUTO" light is off, the manual, indoor and outdoor, Sodium lamps, fluorescent lamps mode can be selected, then the camera red gain and blue gain can be adjusted through the first two knobs on the left side of the keyboard.

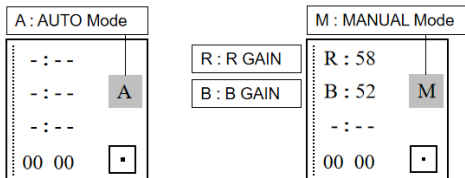

===== 3. Keyboard Description =====

【TRIGGER】 In Onepush mode ("WB PUSH" light is on), the automatic white balance is triggered once.

【AF/MF】 There is the word "AF" next to the button **AF/MF**. When the "AF" light is on, it is the automatic focus mode; when the "AF" light is off, it is the manual focus mode, which can be adjusted by the third knob on the left side of the keyboard.

Note: When the exposure mode and focus mode are both manual, the 3rd knob gives priority to adjusting the focus.

【PUSH FOCUS】 Triggers autofocus once.

3.6.3 Numeric Button Area

【0~9】 + 【SET】 Set the presets.

【0~9】 + Short press 【CALL/CLEAR】 Call the presets.

【0~9】 + Long press 【CALL/CLEAR】 Clear the Presets.

Note: Up to 128 presets can be set and recalled.

3.6.4 Parameters and Speed Adjustment Area

【-SHARPNESS+/-PRESET SPEED+】 Adjust the sharpness. / Adjust the preset speed.

【-WDR+/-PT SPEED+】 Adjust the WDR. / Adjust the camera PT speed.

【-CONTRAST+/-Z SPEED+】 Adjust the contrast. / Adjust the camera zoom speed.

【-SATURATION+/-ZOOM+】 Adjust the saturation. / Adjust the camera lens zoom.

Note: Press the **SHIFT** button to switch between parameter setting mode and speed setting mode, and the display will show "S".

When "S" is shown on the display, these 4 buttons can be used for parameter setting.

===== 3. Keyboard Description =====

When the display does not show "S", these 4 keys can be used for speed setting and zooming.

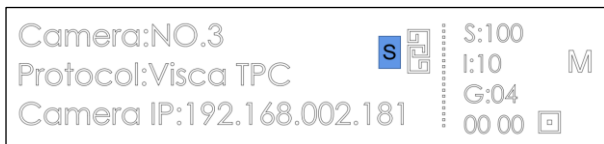

3.6.5 Other Button Areas

【BLC ON/OFF】 Backlight compensation on / off.

【SHIFT】 Switch between parameter adjustment mode and speed adjustment mode.

【SEARCH】 Search for IP addresses.

【HOME/OK】 Return to the original position of the camera.

【POWER/RESET】 Short press to control the camera power, long press to reset the camera.

【CMENU/KMENU】 Short press to open the camera menu, long press to open the keyboard menu.

3.6.6 Joystick Control

【Up】 【Down】 【Left】 【Right】 Offset the joystick to control the camera to 4 directions.

【Zoom+】 Turn the joystick clockwise to zoom in.

【Zoom-】 Turn the joystick counterclockwise to zoom out.

【Lock】 When controlling the camera, press the "lock" button, the camera keeps rotating in the previous control direction until the set lock time is exceeded or the camera rotates to the limit position.



4. Menu Setting



4.1 Operating Instructions:

1. Long press **CMENU/KMENU** to open the keyboard menu; Adjust the joystick **Up** and **Down** to view the menu options; **Right** to enter the next option; **Left** to return to the previous option, short press **CMENU/KMENU** can also return to the previous option; numeric keys **0~9** can set the corresponding parameters in some options.

2. In the keyboard menu, you need to set the corresponding protocol, address in order to control the camera properly.

4.2 Menu options:

System setting	Language	Chinese/English
	Brightness	1~15
	BackLight	AUTO/ON/OFF
	Screen Prt	10s~180s
	DHCP	OFF/ON
	Local IP	192.168.001.180 (Can be set)
	Mask	255.255.255.000
Gateway	192.168.001.001	

Camera setting	Camera	The keyboard can be set with 7 addresses: CAM1~CAM7
	Protocol	VISCA Serial, Pelco-P, Pelco-D, VISCA over IP, VISCA TCP, VISCA UDP, ONVIF, NDI(optional)
	IP Addr / Address	Set the camera IP address or camera address.
	Port / Baudrate	Set the port or baud rate. Default port numbers for each IP protocol: ONVIF: 8000, NDI: 5961, VISCA: 52381
	Username	Username setting, default: admin
Password	Password setting, default: admin	

PTZ setting	Pan Reverse	The left and right direction of the keyboard control can be switched.
	Tilt Reverse	The up and down direction of the keyboard control can be switched.
	Preset PT Spd	Set preset PT speed: 5~24
	Preset Z Spd	Set preset Zoom speed: 1~7
	Focus Speed	Set focus sensitivity: 0~7
	Lock Time	Set of lock time: 2~20(s)

Password setting	New PSD	Set a new password to access the keyboard menu
	Confirm	Reconfirm the new password to access the keyboard menu
	Enable	Password switch to access the keyboard menu
	Version	Keyboard program version number and update date

===== 5. Wiring diagram =====

5.1 Connection in network mode:

5.1.1 The keyboard is on the same LAN as the camera: The keyboard connects to the switch through the network cable, and the camera connects to the switch through the network cable. In the same LAN, set the same network segment, and set the corresponding protocol, IP address and port number, you can control the camera through the keyboard.

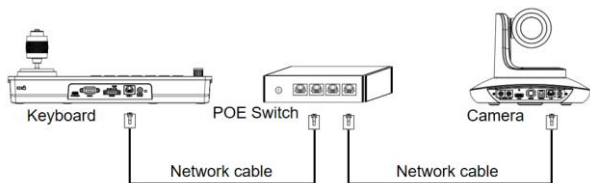

5.1.2 The keyboard is directly connected to the camera: The keyboard is connected to the camera through the network cable, set the same network segment, and set the corresponding protocol, IP address and port number, you can control the camera through the keyboard.

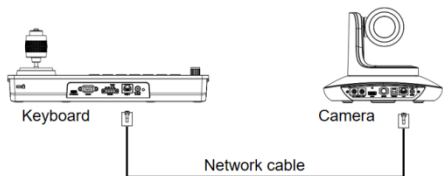

===== 5. Wiring diagram =====

5.2 Connection in RS232 mode:

The keyboard connects to the camera via RS232 cable, set the corresponding protocol, address and baud rate, and you can control the camera via the keyboard.

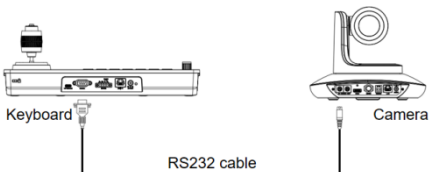

Line Sequence: Using the RS232 connection, pin 1 RXD of the keypad is connected to the camera input interface TXD, pin 2 TXD of the keypad is connected to the camera RXD and pin 3 of the keypad is connected to the camera GND. (It is also possible to use the standard RS232 interface of the control keypad to connect to the camera.)

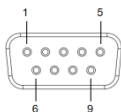

Keyboard	Camera
RXD	←-----→ TXD
TXD	←-----→ RXD
GND	←-----→ GND

DB9 Male (Pin type)	Pin Number	2	3	5	1,4,6	7,8
	Signal Definition	RXD	TXD	GND	Internal connection	Internal connection

===== 5. Wiring diagram =====

5.3 Connection in RS422 mode:

The keyboard connects to the camera via RS422 cable, set the corresponding protocol, address and baud rate, and you can control the camera via the keyboard.

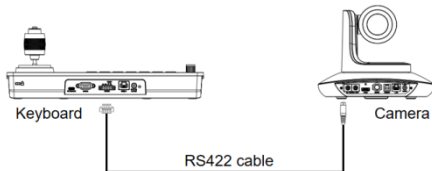

Line Sequence: Using the RS422 bus connection, the keyboard pin 1 TXD + connects to the camera's RXD-, the keyboard pin 2 TXD - connects to the camera's RXD +, the keyboard pin 3 RXD + connects to the camera's TXD -, the keyboard pin 4 RXD - connects to the camera's TXD+.

Keyboard		Camera
TXD +	<----->	RXD -
TXD -	<----->	RXD +
RXD +	<----->	TXD -
RXD -	<----->	TXD +

Note: Some cameras do not support RS422 control.

5.4 Connection in RS485 mode:

The keyboard connects to the camera via RS485 cable, set the corresponding protocol, address and baud rate, and you can control the camera via the keyboard.

5. Wiring diagram

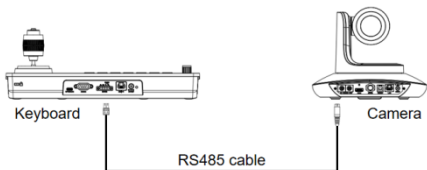

Line Sequence: Using the RS485 bus connection, the keyboard pin 1 TXD + connected to the camera RXD-, the keyboard pin 2 TXD- connected to the camera RXD +.

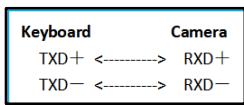

5.5 Cascade in RS232, RS422, RS485 mode:

The keyboard connects the RS232-IN port of camera No. 1 through RS232, RS422, RS485 lines, and then connects the RS232-IN port of camera No. 2 through the RS232-OUT port of camera No. 1 with a cascade line, and finally sets the corresponding protocol, address and baud rate on the keyboard to control camera No. 1 or camera No. 2 through the keyboard.

===== 5. Wiring diagram =====

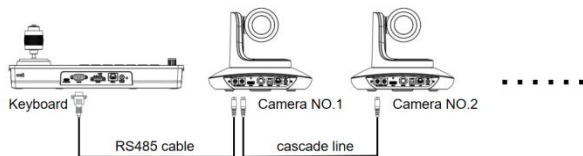

Line Sequence: Using RS232 cascade connection, the output of the keyboard is connected to the input of camera No. 1, the output of camera No. 1 is connected to the input of camera No. 2, and so on.

Keyboard	Camera NO.1	Camera NO.2	Camera NO.3
RXD	<-----> TXD IN	RXD OUT	
TXD	<-----> RXD IN	TXD OUT	
	TXD OUT	<-----> RXD IN
	RXD OUT	<-----> TXD IN	
GND	<-----> GND	<-----> GND	

The connection method using RS422 and RS485 cascade is roughly the same as that of RS232.

===== 6. WEB Configuration =====

6.1 Login WEB

The keyboard and computer connected to the same LAN, open the browser, enter the IP address (default IP address is 192.168.1.188), enter the login interface, you can choose the language (Chinese or English), enter the username and password to login, as shown on the right.

Keyboard Control

Username

Password







Login

(Default username: admin Default password: admin)

After successful login, you will be taken directly to the system configuration screen, as shown below.

System Configuration

-  Device Control
-  Ethernet
-  Firmware Upgrade
-  Reset Options
-  Account

Device Search

All	Search	Manually Add	
Index	IP	Protocol	Actions

Device Configuration

ID	IP	Protocol	Actions
----	----	----------	---------

6.2 Device Control

6.2.1 Device Search

Search for IP addresses and protocols of cameras on the same LAN and add them to the keyboard configuration; you can also add camera IP addresses and protocols manually.

6.2.2 Device Configuration

Modify and delete the IP address, protocol and port number of the already configured camera.

6. WEB Configuration

Device Search

All	Search	Manually Add	
Index	IP	Protocol	Actions
0	192.168.2.101	Onvif	Add

Device Configuration

ID	IP	Protocol	Actions
1	192.168.1.128	VISCA TCP	Config Del

6.3 Ethernet Parameter

Set the network parameters of the keyboard, including DHCP switch, IP Address, Netmask, Gateway, DNS, HTTP Port.

Ethernet

DHCP	<input type="checkbox"/>
IP Address	192.168.1.180
Netmask	255.255.255.0
Gateway	192.168.1.1
DNS	192.168.1.1
HTTP Port	80

Save

6.4 Firmware Upgrade

Check the keyboard device name and version information, and also, you can upload files to upgrade the keyboard system. Please do not power off during the upgrade process.

Firmware Upgrade

Control Version	1.0.0.1
Device Name	TV3308 Camera
Bootloader Version	V1.0.0
System Version	V1.0.0
APP version	V263

Upgrade

6.5 Reset Options

Perform a complete reset or reboot of the keyboard.

Reset/Reboot: Resets all parameters and reboots the device.

Reboot: Reboot the device.

Reset Options

Reset/Reboot

Reset all camera setting to their default values and reboot

Reboot

===== 6. WEB Configuration =====

6.6 Account

Set the login and password of the keyboard.

First enter the Account number that needs to be set, then enter the password that needs to be set twice (Password, Confirm Password), and then click “Save”.

| Account Settings

Account
Password
Confirm Password

Save

After setting the account number and password, please remember the account number and password, otherwise you will not be able to log in the WEB side interface.



7. Frequently Asked Questions



Frequently Asked Questions	
Adverse Description	Solution Ideas
The keyboard cannot control the camera in network mode.	Check if the network cable is connected properly.
	Check whether the camera supports the set protocol.
	Check if the keyboard screen shows connected. The display of "  " indicates a successful connection.
	Check whether the IP address, protocol and port number set on the keyboard are consistent with those of the camera.
	Check if the keyboard and the camera are on the same LAN.
	Check whether the keyboard's local IP address and the camera's IP address are in the same network segment.
The keyboard cannot control the camera in RS232, RS422, RS485 mode.	Check whether the RS232, RS422, RS485 cables are good and whether the interface is loose.
	Check whether T+, T-, R+, R- of RS422 are connected wrongly; check whether T+, T- of RS485 are connected backwards.
	Check that the address, protocol and baud rate set on the keyboard are consistent with those of the camera.
Some cameras can be controlled, some cameras cannot be controlled.	Check if the wiring of each part is normal.
	Check that the parameters of each address code of the keyboard are consistent with those of the respective camera.
When controlled with the keyboard, multiple cameras are controlled together.	Check that the protocols and addresses of the cameras being controlled together are consistent.

