

Prestel HD-PTZ512HM
HD Video Conferencing Camera



User Manual

V1.0

(English)

Preface

Thanks for using this HD Video Conferencing Camera.

This manual introduces the function, installation and operation of the HD camera. Prior to installation and usage, please read the manual thoroughly.

Precautions

This product can only be used in the specified conditions in order to avoid any damage to the camera:

- Don't subject the camera to rain or moisture.
- Don't remove the cover. Otherwise, you may get an electric shock. In case of abnormal operation, contact the authorized engineer.
- Never operating under unspecified temperature , humidity and power supply.
- Please use the soft dry cloth to clean the camera. If the camera is very dirty, clean it with diluted neuter detergent; do not use any type of solvents, which may damages the surface.

Note

This is class A production. Electromagnetic radiation at the specific frequency may affect the image quality of TV in home environment

Note

- **Electric Safety**

Installation and operation must accord with electric safety standard.

- **Caution to transport**

Avoid stress, vibration and soakage in transport, storage and installation.

- **Polarity of power supply**

The power supply of the product is +12V, the max electrical current is 2A .Polarity of the power supply plug drawing as follows.



- **Careful of installation**

Do not grasp the camera head when carrying the camera. Don't turn camera head by hand. Doing so may result in mechanical damage.

Don't apply in corrosive liquid, gas or solid environment to avoid damaging the cover which is made up of plastic material.

To make sure no obstacle in rotation range.

Never power on before installation is not completed.

- **Don't dismantle the camera**

We are not responsible for any unauthorized modification or dismantling.

CAUTION!

The specific frequency of electromagnetic field may affect the image of the camera!

Supplied Accessories

When you unpack, check that all the supplied accessories are included:

Camera	1PCS
AC power adaptor.....	1PCS
Power cord.....	1PCS
RS232 cable.....	1PCS
Remote controller	1PCS
User manual	1PCS

Quick Start

Step1. Please check connections are correct before starting

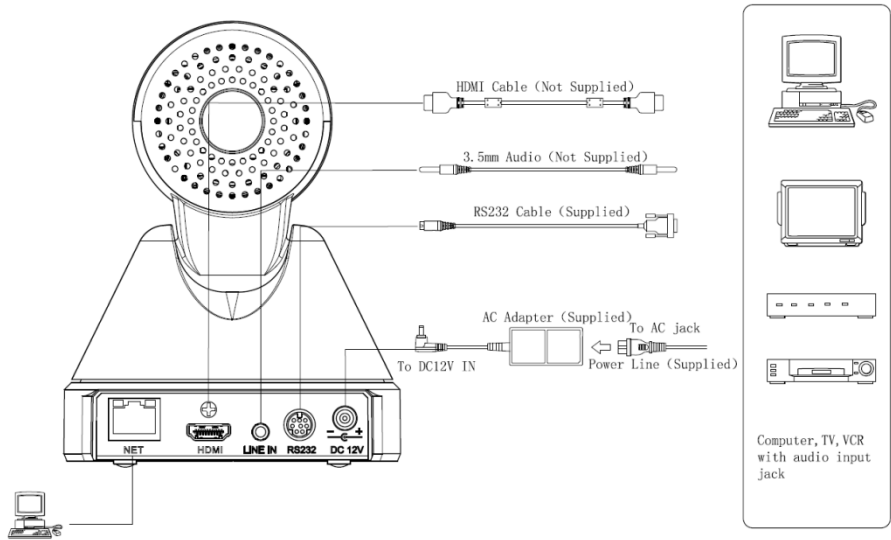

Step2. Connect the power on the rear panel of camera, the camera power indicator on the front panel

Step3. The camera starts to initialize after power-on, Pan-Tilt rotate to the maximum position of upper right, then both horizontal and vertical to the middle position, the motor stops running, initialization complete. (Note: If the position preset 0 has been stored, the position preset 0 will be called up after initialization)

Features

- **Completely New Look**

Designed with worm gear drive, completely new look, mini size, two colors for choosing from.

- **1080P Full HD**

Apply Panasonic's 1/2.7 inch, 2.07 million effective pixels high quality HD CMOS sensor, can reach maximum 1920 x 1080 high resolution and achieve quality image.

- **High frame rate**

1080P output frame rate up to 60fps.

- **72.5 Wide-angle Lens + 32x Digital Zoom**

Use 72.5° wide-angle high quality lens, support 12x optical zoom, and 32x digital zoom (optional).

- **AAC Audio Encoding**

Support AAC audio encoding, better sound quality and smaller bandwidth.

- **Low-light**

High SNR of CMOS sensor combined with 2D and 3D noise reduction algorithm, effectively reduce the noise, even under low illumination conditions, picture can still keep clean and clear.

- **HD Interface**

Support HDMI output, effective transmission distance up to 150 meters (under 1080p30).

- **Remote Control**

Using RS232 interface, all the parameters of the camera can be remote controlled by the high-speed communications.

- **network Interface**

Support network multi-channel audio and video stream output

Product Specification

Model	Prestel HD-PTZ512HM
Name	HD Video Conferencing Camera
Camera	
Sensor	1/2.7 inch, CMOS, Effective Pixel: 2.07M
Scanning Mode	Progressive
Lens	12x, f3.5mm ~ 42.3mm, F1.8 ~ F2.8
Digital Zoom	16x (optional)
Minimal Illumination	0.05 Lux @ (F1.8, AGC ON)
Shutter	1/30s ~ 1/10000s
White Balance	Auto, Indoor, Outdoor, One Push, Manual
Backlight Compensation	Support
Digital Noise Reduction	2D&3D Digital Noise Reduction
Video S/N	≥55dB
Horizontal Angle of View	72.5° ~ 6.9°
Vertical Angle of View	44.8° ~ 3.9°
Horizontal Rotation Range	±170°
Vertical Rotation Range	-30° ~ +90°
Pan Speed Range	1.7° ~ 100°/s
Tilt Speed Range	0.7° ~ 28°/s
H & V flip	Support
Image Freeze	Support
PoE	Support(optional)
Face Detection	Support (optional)
Local Storage	Support
Number of Preset	255
Preset Accuracy	0.1°
IPC Features	
Video coding standard	H.265/H.264/MJPEG
Video Stream	First Stream, Second Stream

First Stream resolution	1920x1080,1280x720,1024x576,960x540,640x480,640x360
Second Stream resolution	1280x720,1024x576,720x576,720x408,640x360,480x270,320x240,320x180
Video Bit Rate	128Kbps ~ 8192Kbps
Bit Rate Type	Variable rate, Fixed rate
Frame Rate	50Hz: 1fps ~ 50fps, 60Hz: 1fps ~ 60fps, 720p120: 120fp(supported by S Model only), 640x480p240: 240fps(Supported by S Model only, optional)
Audio encode standard	AAC
Audio Bit Rate	96Kbps, 128Kbps, 256Kbps
Support protocols	TCP/IP, HTTP, RTSP, RTMP, Onvif, DHCP, Multicast, etc.
Input/Output Interface	
HD Output	1xHDMI: Version 1.3
Network interface	1xRJ45: 10/100/1000M Adaptive Ethernet ports
Audio interface	1-ch 3.5mm audio interface, Line In
Communication interface	1xRS-232: 8pin Min DIN, Max Distance: 30m, Protocol: VISCA/Pelco-D/Pelco-P
Power jack	JEITA type (DC IN 12V)
Generic Specification	
Input Voltage	DC 12V / PoE (802.3af) (optional)
Current Consumption	1.0A (Max)
Operating Temperature	-10°C ~ 40°C (14°F ~ 104°F)
Storage Temperature	-40°C ~ 60°C (-40°F ~ 140°F)
Power Consumption	12W (Max)
MTBF	>30000h
Size	169mm x 142mm x 164mm
Net Weight	1.35Kg (3.0lb)

IR Remote Controller Explanation

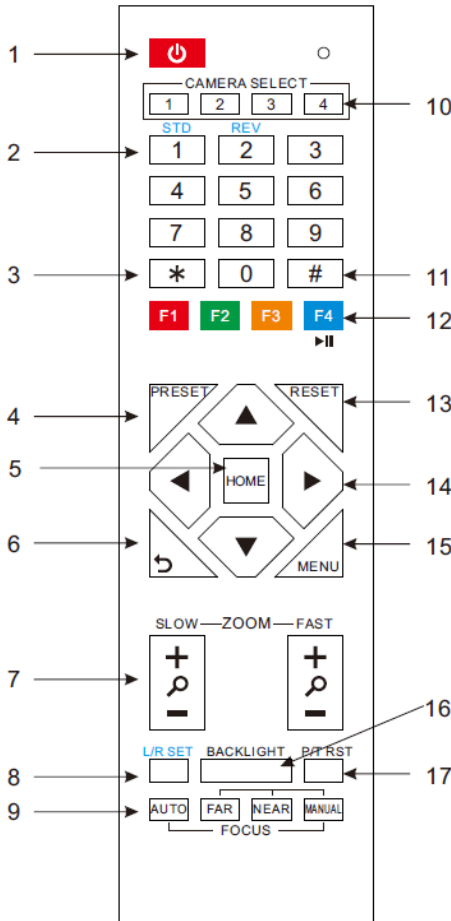

1. Standby Button

Press this button to enter standby mode. Press it again to enter normal mode. (Note: Power consumption in standby mode is approximately half of the normal mode)

2. Position Buttons

To set preset or call preset

3. *Button

Used with other buttons

4. Set/Preset Buttons

Set preset: Store a preset position
 [SET PRESET] + Numeric button (0-9):
 Setting a corresponding numeric key preset position

5. Pan-Tilt control Buttons

Pressing the Pan-Tilt back to the middle position

6. Back buttons

Press the OSD menu return to the superior.

7. Zoom Buttons

Slow Zoom: Zoom In [+] or Zoom Out [-] slowly
 Fast Zoom: Zoom In [+] or Zoom Out [-] fast

8. Pan-Tilt L/R set

Press with 1 buttons and 2 buttons setting the direction of the Pan-Tilt

L/R Set +1[STD]: set the Pan-Tilt turn the same direction as the L/R Set

L/R Set +2[REV]: set the Pan-Tilt turn the opposite direction as the L/R Set

9. Focus Buttons

Used for focus adjustment.

Press [AUTO] adjust the focuses on the center of the object automatically. To adjust the focus manually.

Press [MANUAL] adjust the focus on the center of the object manual

MANUAL button, and adjust it with [Far] (Focus on far object) and [NEAR] (Focus on near object)

10. Camera Select Buttons

Press the button corresponding to the camera you want to operate with the remote controller.

11. # Button

Used with other buttons

12. Set Camera IR Address Buttons

[*]+[#]+[F1]: Address1

[*]+[#]+[F2]: Address2

[*]+[#]+[F3]: Address3

[*]+[#]+[F4]: Address4

13. Clear Preset Buttons

Clear preset: Erase a preset position

[CLEAR PRESET] + Numeric button (0-9)

Or: [*]+[#]+[CLEAR PRESET]: Erase all the preset individually

14. Pan/Tilt Control Buttons

Press arrow buttons to perform panning and tilting.

Press [HOME] button to face the camera back to front

15. MENU

MENU: enter or exit OSD MENU

16. BLC (Backlight Compensation) Button

BLC ON/OFF: Press this button to enable the backlight compensation. Press it again to disable the backlight compensation.(NOTE: Effective only in auto exposure mode)

Note: If a light behind the subject, the subject will become dark. In this case, press the backlight ON / OFF button. To cancel this function, press the backlight ON / OFF button.

17. Pan/Tilt reset

Preset Pan/Tilt self-test.

18. Image freezing function

Manually freeze: Open the freezing function after press the remote control [F4], display "Freeze" on the left upper corner character, after 5 seconds display disappear automatically. If you want to cancel the freeze, press [F4] key and then can return to normal, display "Unfreeze" on the left upper corner, after 5 seconds display disappear automatically.

Recalling the Preset image Freeze: By the OSD Menu Setting "Recalling the Preset image Freeze" function. After the function is opened, the screen will stay in before Recalling the Preset when Recalling the Preset, the screen can be switched to the preset position screen until the camera points to the preset position.

19. Shortcut Set

[*]+[#]+[1]: OSD menu default English

[*]+[#]+[3]: OSD menu default Chinese

[*]+[#]+[4]: Default IP address

[*]+[#]+[5]: Save OSD

[*]+[#]+[6]: Quickly recover the default

[*]+[#]+[8]: Look the camera version

[*]+[#]+[9]: Quickly set up inversion

RS-232 Interface

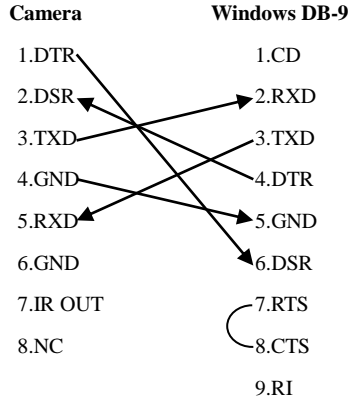
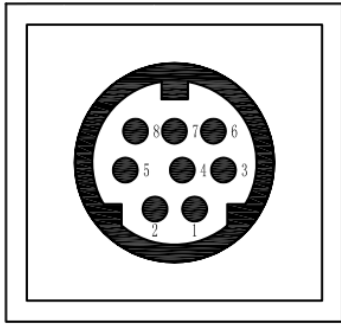

No.	Function
1	DTR
2	DSR
3	TXD
4	GND
5	RXD
6	GND
7	IR OUT
8	NC

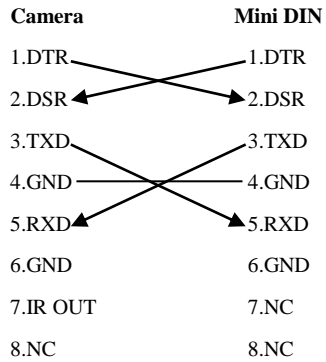

VISCA Network Configuration

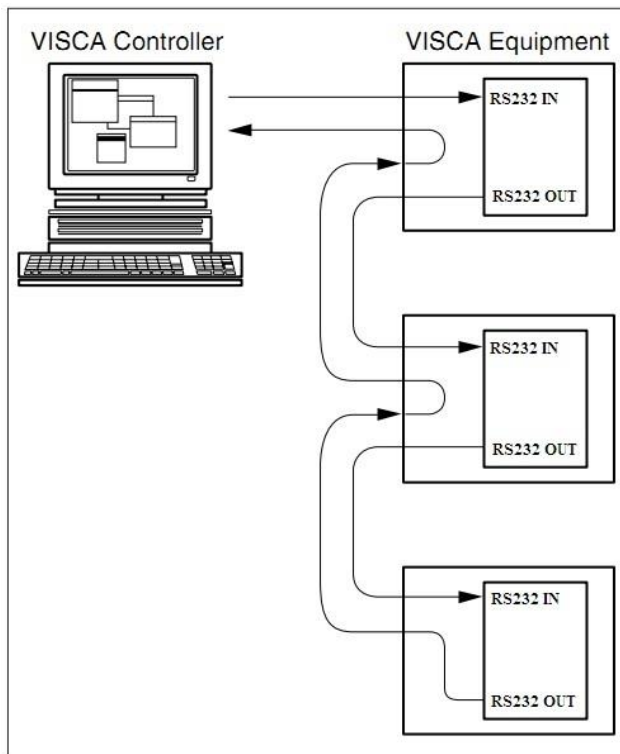

Serial Communication Control

In default working mode, the camera is able to connect to a VISCA controller with RS232C serial interface.

➤ **RS232 Communication Control:**

The camera can be controlled via RS232 ,the parameters of RS232C are as follows:

Baud rate: 2400/4800/9600 bit/s.

Start bit: 1 bit.

Data bit: 8 bits.

Stop bit: 1bit.

Parity bit: none.

➤ **RS485 Communication Control:**

The camera can be controlled via RS485, Half-duplex mode:

Baud rate: 2400/4800/9600 bit/s.

Start bit: 1 bit.

Data bit: 8 bits.

Stop bit: 1bit.

Parity bit: none.

Pan-Tilt will rotate to the maximum position of top right after the camera started, then it return to the center, the process of initialization is finished. (Note: If the position preset 0 has been stored, the position preset 0 will be called up after initialization) Then the users can control the camera with commands in the command list.

PTZ over TCP/UDP Realize

A TCP server has achieved in camera, port number 5678. When the client has established a TCP connection with the server, the client send PTZ control command to the server, the server parsed and executed the PTZ command.

A UDP server has achieved in camera, port number 1259. Client to the server sends the PTZ control command, the server parsed and executed the PTZ command.

Command List

Ignore

Note:

The camera serial standard VISCA/Pelco-D/Pelco-P, if the need for the secondary development, According to standard protocol to control the camera. If you need VISCA/Pelco - D/Pelco - P protocol command list in detail, please contact the manufacturer.

Menu Setting

1.MENU

Press [MENU] button to display the main menu on the normal screen, using arrow button to move the cursor to the item to be set. Press the [HOME] button to enter the corresponding sub-menu.

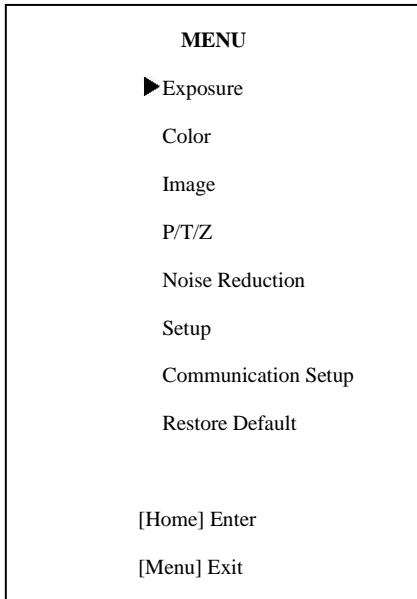

2. EXPOSURE

Move the cursor to the Exposure item in the main menu and press [home] button, EXPOSURE menu appears, as shown in the following figure.

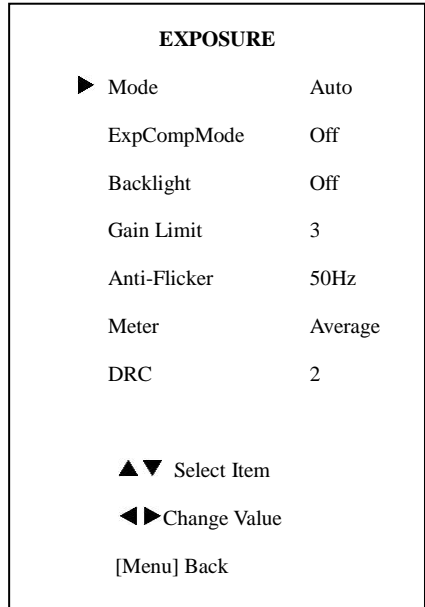

Mode: Exposure mode. Optional items: Auto, Manual, SAE, AAE, Bright

ExpCompMode: Exposure compensation mode, Optional items: On, Off (Effective only in Automode)

ExpComp: Exposure compensation value, Optional items:-7 ~ 7(Effective only in ExpCompMode item to On)

Gain Limit: Maximum gain limit. Optional items: 0 ~ 15 (Effective only in Auto, AAE ,Bright mode)

Backlight: Set the backlight compensation, Optional items: On, Off (Effective only in Auto mode)

Meter: Optional items: Average, Center, Bottom, Top

DRC: DRC strength, Optional items: 0 ~ 8.

Bright: Intensity control, Optional items: 00~17. (Effective only in Bright mode)

Anti-Flicker Flicker: Anti-flicker. Optional items: Off, 50Hz, 60Hz (Effective only in Auto, Bright mode)

Iris: Aperture value. Optional items: F1.8, F2.0,F2.4,F2.8,F3.4,F4.0,F4.8,F5.6,F6.8,F8.0,F9.6 ,F11.0,Close (Effective only in Manual, AAE mode)

Shutt: Shutter value. Optional items: 1/30,1/60,1/90,1/100,1/125,1/180,1/250,1/350,1/500,1/725,1/1000,1/1500,1/2000,1/3000,1/4000,1/6000,1/10000 (Effective only in Manual, SAE mode)

3. COLOR

Move the cursor to the Color item in the main menu and press [home] button, COLOR menu appears, as shown in the following figure.

COLOR	
▶ WB Mode	Auto
RG Tuning	+2
BG Tuning	0
Saturation	100%
Hue	7
AWB sens	Low
▲▼ Select Item	
◀▶ Change Value	
[Menu] Back	

WB-Mode: White balance mode. Optional items: Auto, 3000K/Indoor, 4000K,5000K/Outdoor, 6500K-1,6500K-2,6500K-3,One Push, Manual

RG: Red gain. Optional items: 0~255 (Effective only in Manual mode)

BG: Blue gain. Optional items: 0~255 (Effective only in Manual mode)

RG Tuning: Red gain fine-tuning, Optional items: -10 ~ +10 (Effective only in AWBsens is Low)

BG Tuning: Blue gain fine-tuning, Optional items: -10 ~ +10 (Effective only in AWBsens is Low)

Sat.: Saturation. Optional items: 60% ~ 200%.

Hue: Chroma adjustment, Optional items:0 ~ 14

AWBsens: The white balance sensitivity, Optional items: Normal, High, Low.

4. IMAGE

Move the cursor to the Image item in the main menu and press [home] button, IMAGE menu appears, as shown in the following figure.

IMAGE

▶ Luminance	7
Contrast	7
Sharpness	2
Flip-H	Off
Flip-V	Off
B&W-Mode	Off
Gamma	Default
Style	Clarity

▲▼ Select Item

◀▶ Change Value

[Menu] Back

Luminance: Brightness adjustment. Optional items: 0 ~ 14

Contrast: Contrast adjustment. Optional items: 0 ~ 14

Sharpness: Sharpness adjustment. Optional items: Auto, 0 ~ 15

Flip-H: Image flipped horizontally. Optional items: On, Off.

Flip-V: Image Flip Vertical. Optional items: On, Off.

B&W-Mode: Image color. Optional items: On, Off.

Gamma: Optional items: Default, 0.45, 0.5, 0.56, 0.63.

Style: Optional items: Norm, Clarity, Bright, Soft, 5S.

5.P/T/Z

P/T/Z

▶ SpeedByZoom	On
AF-Zone	Center
AF-Sense	High
L/R Set	STD
Display Info	On
Image Freeze	Off
Digital Zoom	Off

▲▼ Select Item

◀▶ Change Value

[Menu] Back

SpeedByZoom: The depth of field scale switch, Optional items: On, Off

AF-Zone: Interested in focusing area, Optional items: Top, Center, Bottom

AF-Sense: Automatic focusing sensitivity options, Optional items: Low, Normal, High

L/R Set: Optional items: STD, REV

Image Freeze: Optional items: On, Off

Display Info: Optional items: On, Off

Digital Zoom: Optional items: Off, 2x, 4x, 8x,

6. NOISE REDUCTION

Move the cursor to the Noise Reduction item in the main menu and press [home] button, NOISE REDUCTION menu appears, as shown in the

following figure.

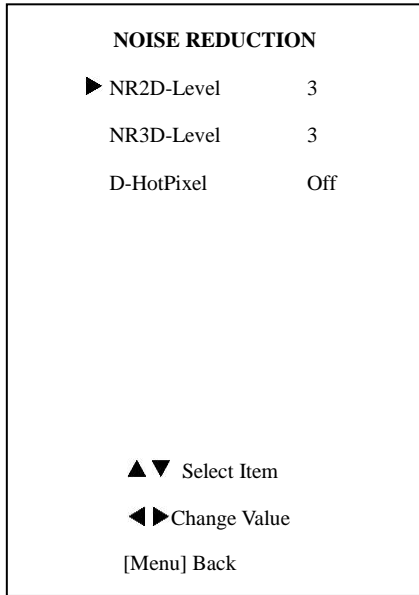

NR2D-Level: 2D noise reduction. Optional items: Off, Auto, 1 ~ 5

NR3D-Level: 3D noise reduction. Optional items: Off, 1 ~ 8

D-HotPixel: Dynamic bad points, Optional items: Off, 1 ~ 5

7. SETUP

Move the cursor to the Setup item in the main menu and press [home] button, SETUP menu appears, as shown in the following figure.

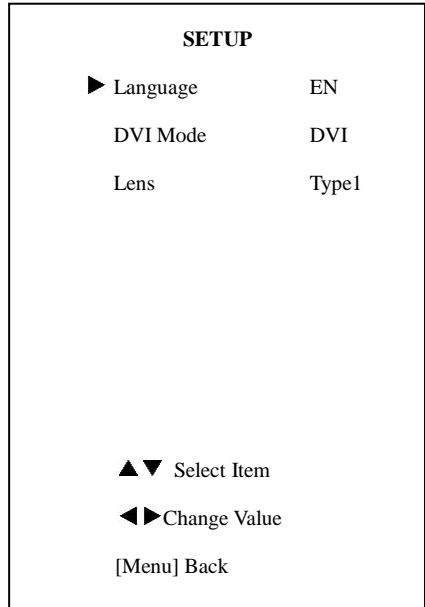

Language: menu language, Optional items: EN, Chinese, Russian

DVI Mode, Optional items: DVI, HDMI

Lens: Lens type. Optional items: Type1, Type2

8. COMMUNICATION SETUP

Move the cursor to the Setup item in the main menu and press [home] button, COMMUNICATION SETUP menu appears, as shown in the following figure.

COMMUNICATION SETUP

▶ Protocol	VISCA
V_Address	1
V_AddrFix	Off
Net Mode	Serial
Baudrate	9600

▲▼ Select Item

◀▶ Change Value

[Menu] Back

Protocol: Control protocol type. Optional items: AUTO, VISCA, PELCO-D, PELCO-P

V_Address: Protocol address, To be decided according to the agreement, AUTO, VISCA protocol Optional items: 1 ~ 7

P_D_Address: PELCO-D protocol Optional items: 0 ~ 254

P_P_Address: PELCO-P protocol Optional items: 0 ~ 31

V_AddrFix: If I can change through the serial port of infrared switch, Optional items: On, Off

(When set to On, useless in 88 30 01 FF Command)

Net Mode: Set the serial port control networking, Optional items: Serial, Paral

Baudrate: Serial port baud rate. Optional items: 2400, 4800, 9600

9.RESTORE DEFAULT

Move the cursor to the Restore Default item in the main menu and press [home] button, RESTORE DEFAULT menu appears, as shown in the following figure.

RESTORE DEFAULT

▶Restore? No

◀▶Change Value

[Home] OK

[Menu] Back

Restore: Confirm restore factory settings.

Optional items: Yes, No

Note: Press [HOME] button to confirm, All parameter restore default, Include IR Remote address and VISICA Address

Save: Save Options. Optional items: Yes, No

Network Function

1 Operating Environment

Operating System: Windows 2000/2003/XP/ vista/7/8

Network Protocol: TCP/IP

Client PC: P4/128MRAM/40GHD/ support scaled graphics card, support DirectX8.0 or more advanced version.

2 Equipment Installation

- 1) Connect internet camera to your internet or to your PC directly via internet cable.
- 2) Turn on DC12V power.
- 3) The orange light of internet port lit on, green light flashing, and the physical connection finished.

3 Internet Connection

Connection ways between internet camera and computer, as picture 1.1 and picture 1.2 shown:



Picture 1.1 connect by internet cable

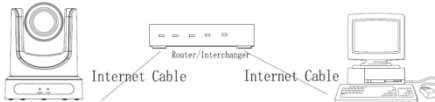

Picture 1.2 Connect by router /interchanger

4 IP camera visited/ controlled by LAN

4.1 Setup IP address

IP camera default IP address"192.168.100.88", Unknow camera IP, view as below:

Method 1: press * and # and 4 on remote controller one by one, the camera IP address will be shown on screen.

Method 2: connect camera to PC with ethernet cable, use "upgrade_En.exe" to search for IP address



Change IP address,2 methods as below:

Method 1: On web control page, find "Network"--->Change IP---->Click "Apply"-----> Restart camera

A screenshot of a web control page for a camera. The page is titled "Lan Settings" and has a blue background. It contains several sections of settings:

- IP Configuration Type:** Fixed IP Address (selected)
- IP Address:** 192.168.100.87
- Subnet Mask:** 255.255.255.0
- Gateway:** 192.168.100.1
- DNS Address:** 8.8.8.8
- MAC Address:** D4 E0 8E 1E 18 C0
- Port Settings:**
 - HTTP Port number: 80 (80)
 - RTSP Port: 554 (554)
 - PTZ Port: 5678 (5678)
- Control Protocol Settings:**
 - Visca Address: 1 (1~7)
 - Pelco-D Address: 0 (0~255)
 - Pelco-P Address: 0 (0~31)
- RTMP Settings:**
 - First stream: On Off Video Audio
 - MRL: rtmp://192.168.100.138/live/stream0
 - Second stream: On Off Video Audio
 - MRL: rtmp://192.168.100.138/live/stream1
- RTSP Settings:**
 - RTSP Auth: On Off
- ONVIF Settings:**
 - ONVIF: On Off
 - ONVIF Auth: On Off
- Multicast Settings:**
 - Multicast: On Off
 - Address: 224.1.2.3
 - Port: 6688
- SDK Settings:**
 - Active Connection: On Off
 - Address: 192.168.100.138
 - Port: 1234

Buttons for "Apply" and "Cancel" are located at the bottom of each section.

Method 2: Open "upgrade_En.exe", change IP and click "Set". After modified, IP Camera be restart.

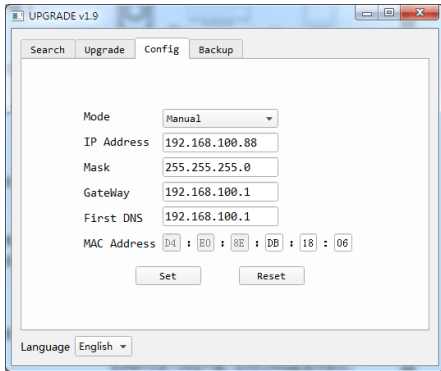

NOTE!

IP camera default IP address "192.168.100.88", user "admin", password "admin".

4.2 Visit/Access IP Camera

Input `http://192.168.100.88` to IE (better with IE web browser, others will cause little latency), a login window pop up, input login name: admin, password: admin, shown as below:



After login, shown as below:



NOTE!

If user first time use this camera by internet (only for new user), must install a player software (VLC). Please go to VLC website <http://www.videolan.org/vlc/download> and install VLC (player software). After installation, login again, will show as above:

5 IP Camera accessed/controlled by WAN (internet)

5.1 Setup IPC accessed/controlled by dynamic DNS

2 dynamic DNS available:

Dyndns.org,
3322.org

Router Port Mapping:

Take Tenda router for example, enter Router Home Page (interface page), select "Advanced"- "Virtual Server", add a new port number in "Ext Port", add a new port number in "Int port", put camera IP address to "Internal IP", then select "Save", shown as below:

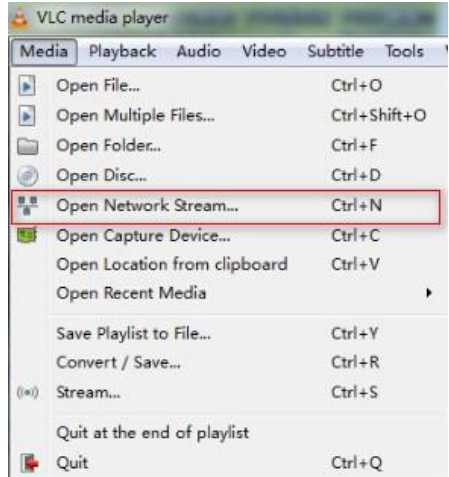
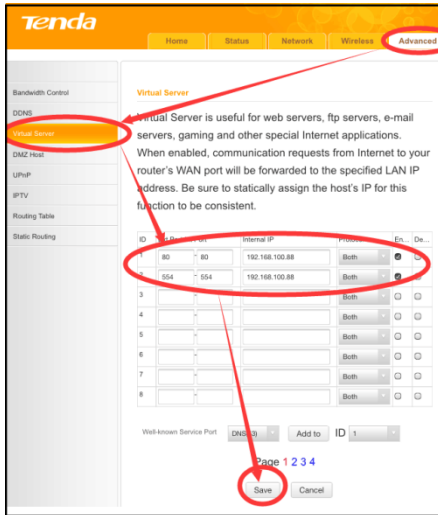

Input URL address:

rtsp://ip: port number/1 (First stream);

rtsp://ip: port number/2 (Second stream).



NOTE!

RTSP port number default 554.

5.2 Dynamic DNS visit camera

Set domain name to camera, setup the parameter, then dynamic DNS can access camera. Access link: <http://hostname :port number> For example, setup host computer name: youdomain.f3322.org, camera port number: 554, Access link should be: <http://youdomain.3322.org:554>.



NOTE!

If camera port default as 80, then unnecessary to input port number, use host name can access camera directly .

5.3 VLC stream media player monitoring

Visit VLC media server procedure

Open VLC media player, click "Media"-> "Open Network Steam", or click "Ctrl+N"; as below:

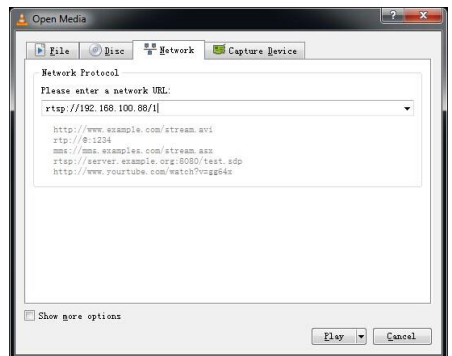

6 IP Camera parameter setup

6.1 Homepage introduction

Menu

All pages include 2 menu bars:

Real time monitoring: displaying video

image Parameter setup: with function buttons

A. Video viewing window

Video viewing window must be same as video resolution, the bigger the resolution is, the bigger the playing area is. Double click viewing window, will show full-screen, double click again, will return to initialized size.

Status bar in viewing window shown as below



- 1) Video playback pause button: control real-time video pause, stop the last picture, click recoverable video again.
- 2) Audio control buttons: can set silent mode.
- 3) Full screen switch button.

B. PTZ Setup

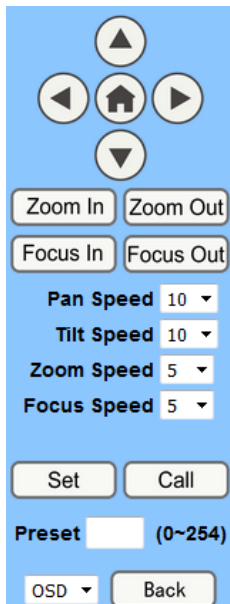

1) PTZ direction control box: Up, down, left, right, home oblique button as above

2) Rate: Vertical speed can be chosen as 1 ~ 24, horizontal direction at the rate of 1 ~ 20.

3) select corresponding speed and click direction button to realize PTZ speed up or speed down.

4) Zoom In/Zoom out: for zooming in or

zooming out, Focus In/ Focus Out: Focusing on distant objects or Focusing on close objects.

5) Set/Call: When PTZ turn to expected position, can set up preset that user want as below.

Method 1: Type a number into the Preset box.



Method 2: Type name into the Preset information.

Presets Information		
No.	Name	
1	<input type="text"/>	Set
2	<input type="text"/>	Set
3	<input type="text"/>	Set
4	<input type="text"/>	Set
5	<input type="text"/>	Set
6	<input type="text"/>	Set
7	<input type="text"/>	Set
8	<input type="text"/>	Set
9	<input type="text"/>	Set

Then click "Set" button, when PTZ turn to other position, click "Call" button or click "No." of the Presets Information, PTZ turn back to preset position.



6) PTZ / MENU, MENU: system in menu mode, OSD menu display in the upper corner of

the image page. PTZ direction control box: Up/down button select menu. and the home button enter the submenu, the left/right button modify the submenu. After the menu to be modified. select PTZ, If in the main menu, save the setting and exit automatically. Otherwise, return to the previous menu. Back effective only in submenu.

PTZ : system in PTZ mode.

C. Language selection

Language English

Chinese/English/Russian

6.2 Media

Video Setup, please click "Video"

Video Settings

Video Format: Dial Priority

Encode Level: mainprofile

First stream

Encode Protocol: H264

Resolution: 1920x1080

Bit Rate: 4096 (32~20480) kbps

Frame Rate: 30 fps

I Key Frame Interval: 30 (2~150)

Bit Rate Control: CBR VBR

Fluctuate Level: 1

Second stream

Encode Protocol: H264

Resolution: 320x240

Bit Rate: 1024 (32~6144) kbps

Frame Rate: 30 fps

I Key Frame Interval: 30 (2~150)

Bit Rate Control: CBR VBR

Fluctuate Level: 1

Apply Cancel

1) Video format

Support 50HZ(PAL)and 60HZ(NTSC),

and Dial priority three formats.

2) Encode Protocol

Support H.264 , H.265and MJPEG three formats.

3) Encode Level

Support baseline, mainprofile, highprofile three levels.

4) Resolution

First stream support 1920x1080,1280x720, 1024x576,960x540,640x480,640x360, second stream support1280x720,1024x576,720x576, 720x408,640x360,480x270,320x240,320x180,the bigger resolution is, the clearer the image will be, more network bandwidth will be taken.

5) Bit Rate

User can assign bit flow/stream, normally speaking, the bigger bit flow is, the clearer the image will be. The bit allocation must combine with network bandwidth, when the network bandwidth is too narrow and the allocated bit flow is too big, will cause video signal flow not to be transmitted normally, the video effect will be worse.

6) Frame rate

User can specify the size of the frame rate, generally, the frame rate greater, the image more smooth; Frame rate is smaller, the more sense of beating.

7) I key frame interval:

Set interval between 2 I frame, the bigger interval is, the response will be lower from viewing window.

8) Bit Rate control

Code stream control way:

Constant bit rate: video coder will be coding according to preset speed

Variable bit rate: video coder will adjust the speed based on preset speed to gain the best image quality.

9) Fluctuate level

Restrain the fluctuation magnitude of variable rate, grade 1 ~ 6

6.3 Image Setup, please click "Image"



1) Brightness

Image bright 0~14, slider control, on the right shows the corresponding numerical. Default 7.

2) Saturation

Saturation 0~14, slider control, on the right shows the corresponding numerical. Default 4.

3) Contrast

Contrast 0~14, slider control, on the right

shows the corresponding numerical. Default 7.

4) Sharpness

Sharpness 0~15, slider control, on the right shows the corresponding numerical. Default 2.

5) Hue

Hue 0~14, slider control, on the right shows the corresponding numerical. Default 7.

6) Flip & Mirror

Tick Flip to realize image upside down, tick mirror to realize image around the mirror. Default not tick.

7) Button

Adjusting the parameters, press "apply" button to save, press "cancel" button to cancel the adjustment of the parameters, press "default" button obtain the default value.

6.4 Audio Setup, please click "Audio"

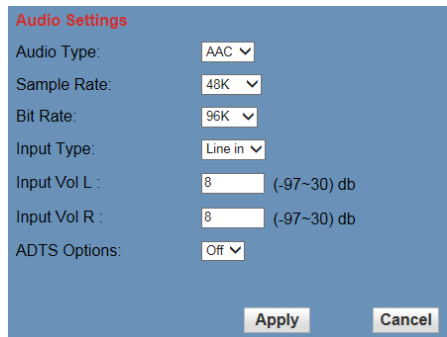

1) Audio Type

Audio type AAC

2) Sample rate

Sample rate 44.1 K and 48 K, selectable.

3) Bit rate

Bit rate 96k,128k,256k, selectable

4) Input Type

line in only

5) Input VolL

The volume of the left channel

6) Input VolR

The volume of the right channel

7) ADTS Options

Optional items: On, Off

8) Button

Press "apply" button to save parameters, press

"cancel" button to cancel parameter

6.5 System Setting, please click "System"



1) Work Mode

Work Mode RTSP

2) Reboot

Click the "Reboot" button, system restart.

3) User and password

The user can modify the password (letters and Numbers only)

4) Apply / Cancel

Modify password and click the "apply" button to the login page, press "cancel" button to cancel password change.

6.6 Network Setting, please click "Network"

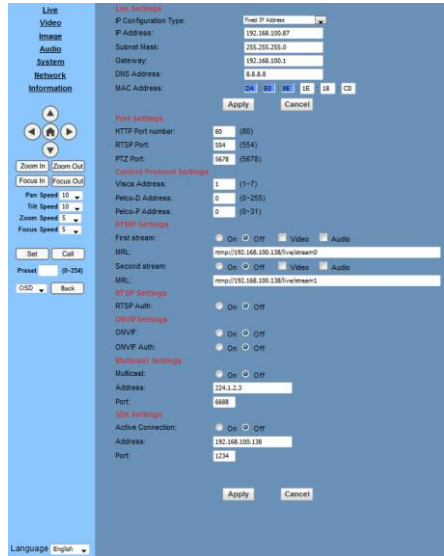

1) Lan Settings

Default the IP address is 192.168.100.88, The MAC address can be modified.

2) Port Settings

A. HTTP Port

IP address identifies the network device, the device can run multiple web applications, each network program using network port to transmit data, so data transmission to be carried out between the port and port. Port setting is to set up WEB SERVER program using which port to transmit. When port mapping, need to be consistent with the port number(default port: 80)

B. RTSP Port

Network camera support RTSP protocol, use the VLC tools broadcast.

C. PTZ Port

Support PTZ protocol, default port: 5678.

3) Control Protocol Setting

Setting camera control communication protocol, include Visca address, Pelco-D address, Pelco-P address.

4) RTMP Setting

Setting the camera stream, can set up two stream, in the two stream selection control code stream of "On", "Off", "Video", "Audio", etc.

5) RTSP Setting

Setting network camera rtsp protocol of "On", "Off".

6) ONVIF Setting

Setting the ONVIF protocol and ONVIF authorization "On", "Off".

7) Multicast Setting

Setting multicast "On", "Off", and multicast address (default address 224.1.2.3) and port (default 6688)

8) Apply / Cancel

Modify network parameters then press "Apply" button to modify network parameters, press "Cancel" button to cancel network parameters.

6.7 Device Information, please click

"information"

Show the current device information, as shown below.

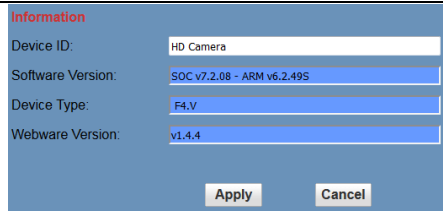

7 Download the Network upgrade program

If you need the camera upgrade program, please contact the manufacturer.

Maintenance and Troubleshooting

Camera Maintains

- If camera will not be used for a long time, please turn off the power switch, disconnect AC power cord of AC adaptor to the outlet.
- Use soft cloth or tissue to clean the camera cover.
- Please use the soft dry cloth to clean the lens. If the camera is very dirty, clean it with diluted neuter detergent. Do not use any type of solvents, which may damages the surface.

Unqualified Application

- No shooting extreme bright object for a long period of time, such as sunlight, light sources, etc.
- No operating in unstable lighting conditions, otherwise image will be flickering.
- No operating close to powerful electromagnetic radiation, such as TV or radio transmitters, etc.

Troubleshooting

Image

- No image
 1. Check whether the power cord is connected, voltage is OK, POWER lamp is light.
 2. Check whether the camera can self-test after startup.
 3. Check video cable is connected correctly.

- Abnormal display of image
Check video cable is connected correctly.

- Image dithering even at widest zoom position
 1. Check whether camera is fixed correctly.
 2. Make sure if there are something like vibration machine or other things nearby.

- IE browser not video image IE

When IPC first time accessed by Internet Explore (IE or other web browser), must install plug-in. User first time use this camera by internet (only for new user), must install a player software (VLC). Please go to VLC website <http://www.videolan.org/vlc/download> and Install VLC (player software). After installation, login again, will show image, the video image is displayed.

- Unable to access IP Camera by IE browser.
 1. Access to the network with PC can test whether network works, in this way to get rid of cable failure, network failure caused by PC virus until the PC can be Ping.

-
2. Disconnect IP Camera with network, IP Camera and PC are connected, according to the proper operations to re-set the IP address.
 3. Check the server's IP address and subnet mask and gateway address.
 4. MAC addresses conflict.
 5. Web port is occupied by other devices.
- When modify IP address in an incorrect way cause the wrong IP address or forget web passwords, press the IR remote controller "[*]+[#]+[Manual]" to restore the default value (Default IP: 192.168.100.88 Default username: admin Default password: admin)

Control

- IR remote controller cannot control the camera
 1. Change the battery
 2. Check the camera working mode.
 3. Check IR address of the Remote Commander is set correctly.

- Serial communication cannot control the camera
 1. Check the camera working mode.
 2. Check control cable is connected correctly.