

HD Color Video Camera

User Manual

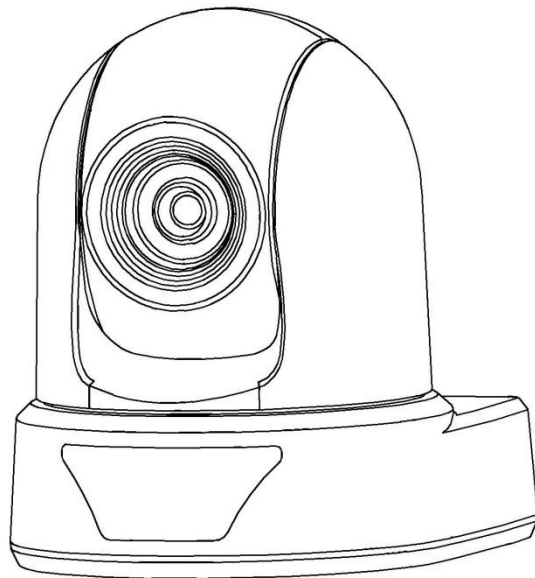

Foreword

Thank you for selecting this series of Video Conference Cameras.

Please read and understand this Operations Manual before using the product.

Warning!

To prevent this product or any other products connected from damage, this product can only be used within a predetermined range.

- Avoid raining or moisture environment;
- Do not remove Product Casing. Use certified personnel for installation and reparation;
- Do not use beyond the limitation of temperature, humidity or power voltage range;
- When cleaning the camera lens, use a soft, dry cloth, when serious dirty, please use a mild detergent and wipe gently. Never use strong cleaning agents or with corrosive, so as not to scratch the lens and affecting image quality

Notes

This manual covers the installation and use a variety of models of our company's products, please distinguish the product's features, parameters, and their installation instructions according to the ordered products model No..

Content

Attentions

Accessory

Quick Starting

Camera Performance

Camera Interface Explanation

- 1.Interface
- 2.VISCA RS-232C IN
- 3.VISCA RS-232C OUT
- 4.Computer or keyboard and camera connection method
- 5.VISCA networking as shown below

Remote controller

Serial Communication Control

MENU SETTING

Dimension

Camera Maintenance and Troubleshooting

IP Camera Network Function

1. Camera Maintenance
2. Troubleshooting

Attentions

▼ Electric Safety

Installation and operation must accord with electric safety standard

▼ Caution to transport

Avoid stress, vibration and soakage in transport, storage and installation.

▼ Polarity of power supply

The power supply of the product is $\pm 12V$, the max electrical current is 2A. Polarity of the power supply drawing.

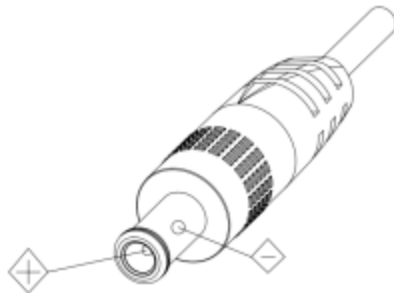

▼ Careful of installation

Never move the camera by seizing the camera head. Don't rotate camera head by hand; otherwise, mechanical trouble will occur.

This series item must put on the smooth desk or platform, and it cannot be installed slant ways;

If the camera is installed on TV or computer, the base can be fixed by four double-sided adhesive trays.

Don't apply in corrosive liquid, gas or solid environment to avoid the cover which is made up of organic material.

To make sure no obstacle in rotation range.

Never power on before installation is completed.

▼ Don't disassemble discretionarily.

We are not responsible for any unauthorized modification or dismantling.

⚠ Attention!

Electromagnetic field under certain rate may affect camera image!

Accessory

When you unpack, check that all the supplied accessories are included:

Camera.....	1 pcs
Power Adapter.....	1 pcs
Wall Mounting Bracket or Upside-Down Mounting Bracket.....	1 set
RS232 Cable.....	1 pcs
IR Remote Controller.....	1 pcs
User Manual.....	1 set
USB3.0 Cable(USB3.0 Cameras Only).....	1 pcs

Quick Starting

1. Please make sure all wiring are correct before power on.

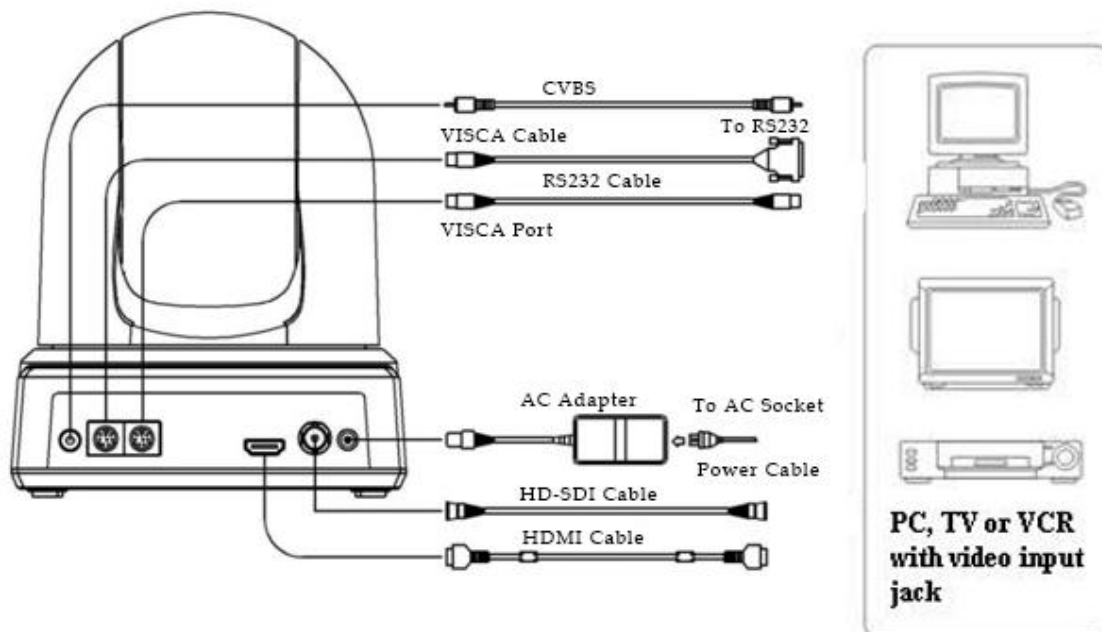

SDI + HDMI and 5G Wireless Series Wiring Diagram

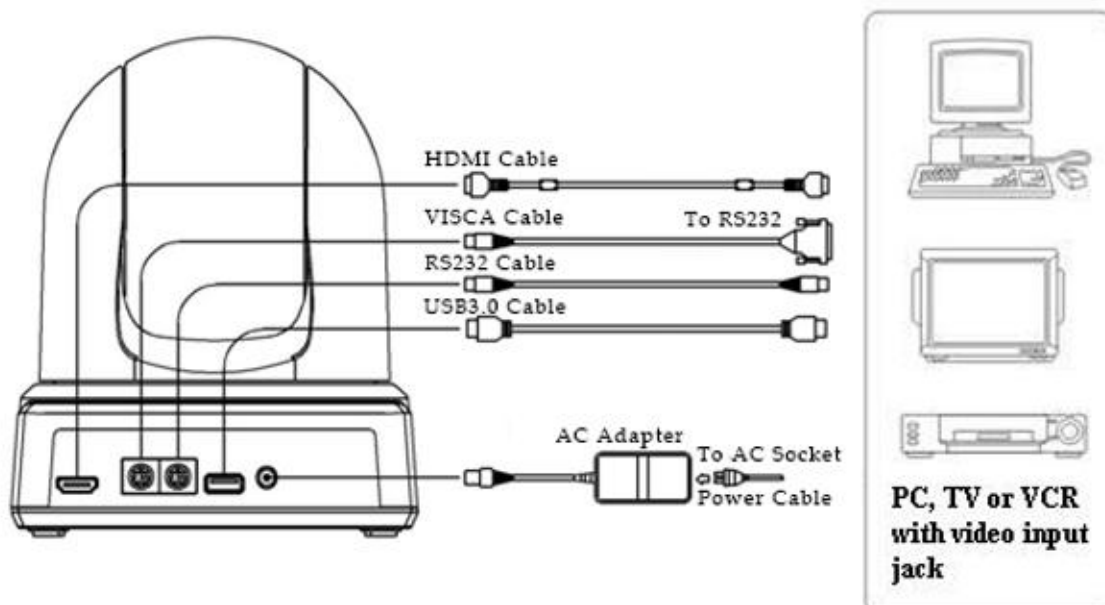

USB3.0 + HDMI Series Wiring Diagram

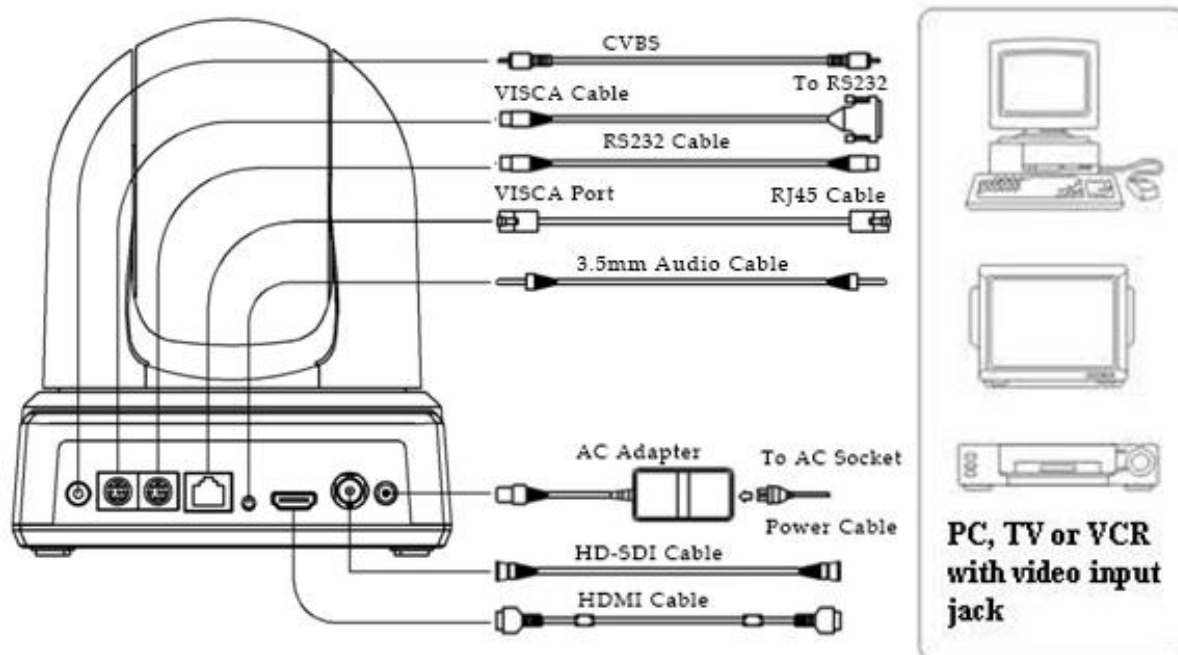

HDBaseT Series Wiring Diagram

2. Setting of Bottom Switch

	SW.1	SW.2	SW.3	SW.4	SW.7	SW.8
1080P60	OFF	OFF	OFF	OFF	-	-
1080P50	ON	OFF	OFF	OFF	-	-
1080I60	OFF	ON	OFF	OFF	-	-
1080I50	ON	ON	OFF	OFF	-	-
720P60	OFF	OFF	ON	OFF	-	-
720P50	ON	OFF	ON	OFF	-	-
1080P30	OFF	ON	ON	OFF	-	-
1080P25	ON	ON	ON	OFF	-	-
Custom	ON	ON	ON	ON		
Working mode	-	-	-	-	OFF	ON
Update C					OFF	OFF
Update A	-	-	-	-	ON	OFF

Notices:

- Please power on the camera again, after change the resolution
- Camera can only work when SW.7 OFF and SW.8 ON
- Please keep the SW.5 OFF

3. Power on the camera, its head moves from bottom left to the bottom right, and then go to the HOME position (intermediate position of both horizontal and vertical)

Note: If have set preset 0, when Power on self-test is completed, the camera automatically moves to the preset 0 position.

Camera performance

This series camera offers perfect functions, superior performance and rich interfaces. The features include advanced ISP processing algorithms to provide vivid images with a strong sense of depth, high resolution and fantastic color rendition. IP Version Camera supports H.264/H.264+ encoding which makes motion video fluent and clear even with less than ideal bandwidth conditions.

1. **Superb high-definition image:** It employs high quality CMOS sensor. Resolution is up to 1920x1080 with frame rate up to 60 fps.
2. **Various optical zoom lens:** It has 10X/12X/20X/30X optical zoom lens for options. The 12x zoom lens is with 72.5 ° wide view angle without distortion.
3. **Leading Auto focus technology:** Leading auto focus algorithm makes lens a fast, accurate and stable auto-focusing.
4. **Low noise and High SNR:** Low Noise CMOS effectively ensure high SNR of camera video.
Advanced 2D/3D noise reduction technology is also used to further reduce the noise, while ensuring image sharpness.
5. **Quiet PTZ:** By adopting high accuracy Servo Algorithm for PTZ Control, Precise location($\pm 0.01^\circ$), it works extremely quiet and moves smoothly and very quickly to designated position.
6. **Multiple remote controls:** There is IR Remote Controller. RS232, RS485. Support transparent transmission function.
7. **Support Multiple Control Protocol:** Support VISCA, PELCO-D, PELCO-P protocols which can also be automatically recognized. Support VISCA control protocol through IP port.
8. **RS-232 cascade function:** ST series support RS-232 cascade function which is convenient for installing.
9. **255 presets positions:** Up to 255 presets.
10. **Wide application:** Tele-education, lecture capture, Webcasting, Videoconferencing, Tele-training, Tele-medicine, Interrogation and Emergency command systems.
11. **Support Multiple Video Interface:** HDMI, HD-SDI(3G), HDBaseT, USB3.0, CVBS. Please check the specifications of the camera.

Model No.	SDI+HDMI	5G Wireless	HDBaseT	USB3.0
Camera				
Video Format	HD: 1080p/60, 1080p/50, 1080i/60, 1080i/50, 1080p/30, 1080p/25, 720p/60, 720p/50			USB3.0: 1080p60/50/30/25, 720p60/50/30/25, 800*600P60/50/30/25, 640*480P60/50/30/25
Sensor	2.1Megapixels, 1/2.8 inch high quality HD CMOS sensor			
Signal System	Progressive			
Optical Zoom	20X, F1.6~F3.5, f4.7~94mm			
Digital Zoom	12X			
Minimum Illumination	1Lux@F1.6(color), 0.01Lux@F1.6(black&white)			
Shutter Speed	1/30s ~ 1/10000s			
White Balance	Indoor/Outdoor/Auto/Manual			
BLC	Yes			
DNR	2D & 3D DNR			
SNR	≥ 52 dB			
Horizontal View Angle	58.7 °~ 3.2 °			
Vertical View Angle	45.0 °~ 2.4 °			
Pan Rotation	$\pm 175^\circ$			
Tilt Rotation	-30 °~ +210 °			
Pan Control Speed	1 %s ~ 100 %s			
Tilt Control Speed	1 %s ~ 60 %s			

Image Flip	Up/Down, Left/Right			
Preset Number	255			
Accuracy of Preset	0.1			
Input / Output Interface	SDI+HDMI	5G Wireless	HDBaseT	USB3.0
HD Video Output	HDMI, HD-SDI	HDMI, HD-SDI, 5G Wireless	RJ45(HDBaseT), HDMI, HD-SDI	HDMI, USB3.0
SD Video Output	CVBS(RAC)			
Communication Interface	1* RS-232 IN: 8 pin min DIN, Longest Distance 30m, VISCA/Pelco-D/Pelco-P			
	1* RS-232 OUT: 8 pin min DIN, Longest Distance 30m, VISCA Daisy Chain			
	1* RS-485: 8 pin min DIN(same port with RS-232 IN), Longest Distance 1200m, VISCA/Pelco-D/Pelco-P			
Power Interface	JEITA Type (DC IN 12V) HEC3800			
Operation System	Windows XP (USB2.0) , Windows Vista, Windows 7, Windows 8, Mac OS X, Linux			
USB Communication Protocol	No			UVC1.1
USB for PTZ Control	No			Yes
Wireless Transmit Distance	No	50 Meters	No	
Wireless Working Frequency	No	5GHZ	No	
RF Communication System	No	2X2MIMO	No	
Wireless Modulation Mode	No	OFDM	No	
Wireless Standard	No	802.11n	No	
Wireless Signal Compression	No	H.264	No	
Wireless Time Delay	No	160ms	No	
Others				
Power Adapter	AC110V-AC220V to DC12V/2A, DC12V(DC11.5-DC12.5V)			
Working Temperature	0°C ~ 45°C			
Storage Temperature	-10°C ~ +60°C			
Power Consumption	18W(MAX)			
Dimensions	155mm*186mm*172mm			
Weight	2.5KG(1.3KG)			

Camera Interface Explanation

1.Interface

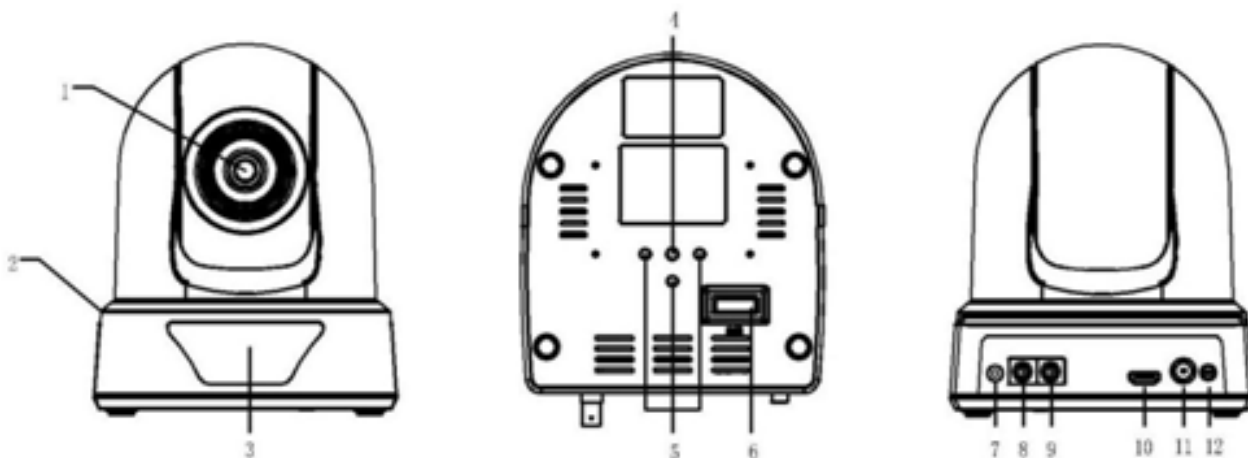

SDI + HDMI and 5G Wireless Series Wiring Diagram

- | | |
|-------------------------------------|-------------------------------------|
| 1. Camera lens | 2. Camera base |
| 3. Remote Controller Receiver light | 4. Hole Tripod screw hole |
| 5. Installation Orientation Hole | 6. Dip switch |
| 7. CVBS Port | 8. RS232 IN |
| 9. RS232 OUT | 10. HDMI Port |
| 11. HD-SDI Port | 12. DC12V Input Power Supply Socket |

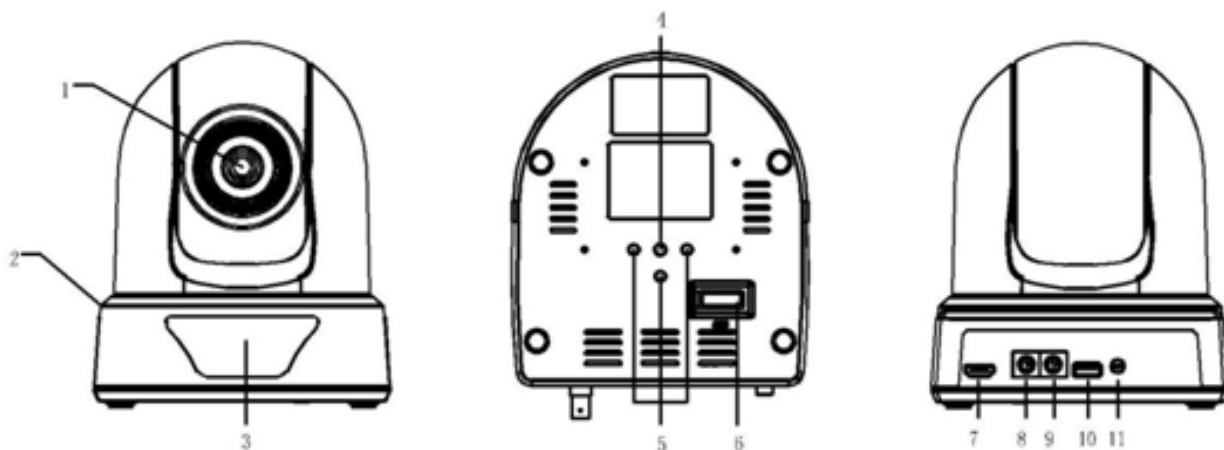

USB3.0 + HDMI Series Wiring Diagram

- | | |
|-------------------------------------|---------------------------|
| 1. Camera lens | 2. Camera base |
| 3. Remote Controller Receiver light | 4. Hole Tripod screw hole |
| 5. Installation Orientation Hole | 6. Dip switch |
| 7. HDMI Port | 8. RS232 IN |
| 9. RS232 OUT | 10. USB3.0 Port |
| 11. DC12V Input Power Supply Socket | |

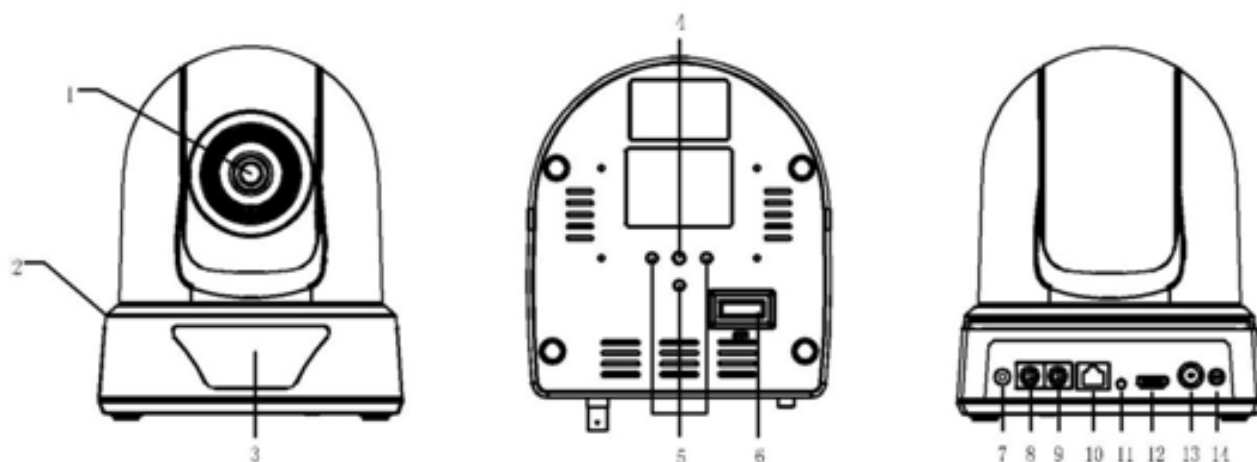

HDBaseT + HDMI + HD-SDI Series Wiring Diagram

- | | |
|-------------------------------------|-------------------------------------|
| 1. Camera lens | 2. Camera base |
| 3. Remote Controller Receiver light | 4. Hole Tripod screw hole |
| 5. Installation Orientation Hole | 6. Dip switch |
| 7. CVBS Port | 8. RS232 IN |
| 9. RS232 OUT | 10. HDBaseT Port |
| 11. Audio Input Port(not support) | 12. HDMI Port |
| 13. HD-SDI Port | 14. DC12V Input Power Supply Socket |

2. VISCA RS-232C IN

No.	Function
1	DTR IN
2	DSR IN
3	TXD IN
4	GND
5	RXD IN
6	485-A
7	IR
8	485-B

VISCA RS-232C IN

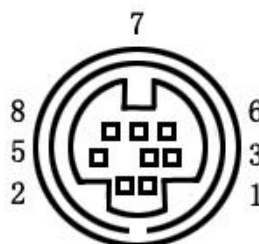

3. VISCA RS-232C OUT

No.	Function
1	DTR OUT
2	DSR OUT
3	TXD OUT
4	GND
5	RXD OUT
6	GND
7	IR
8	IR

VISCA RS-232C OUT

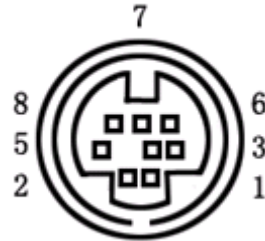

4. Computer or keyboard and camera connection method

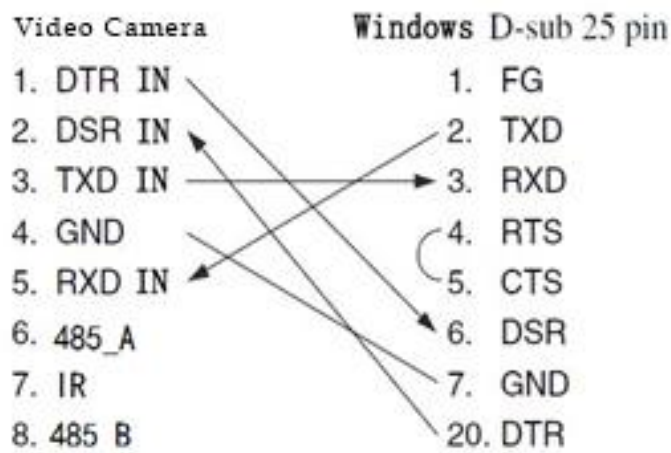

5. VISCA networking as shown below

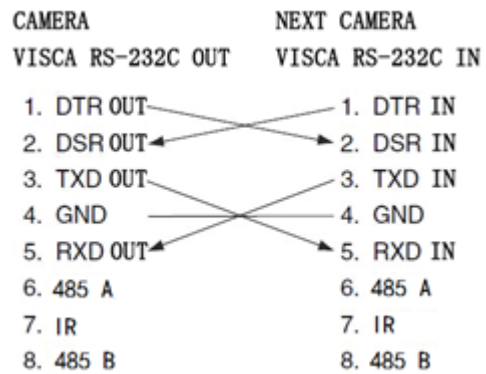
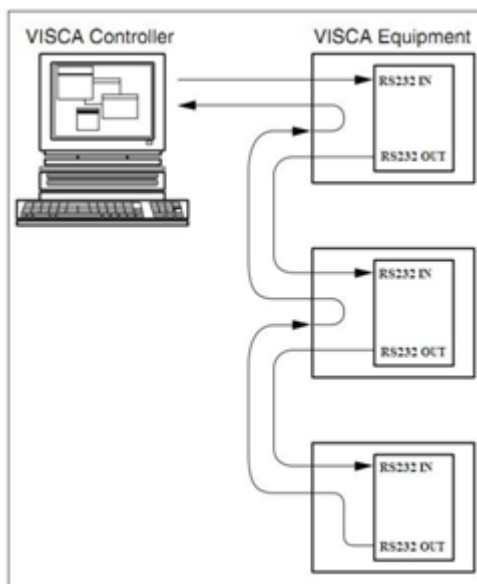

Remote controller

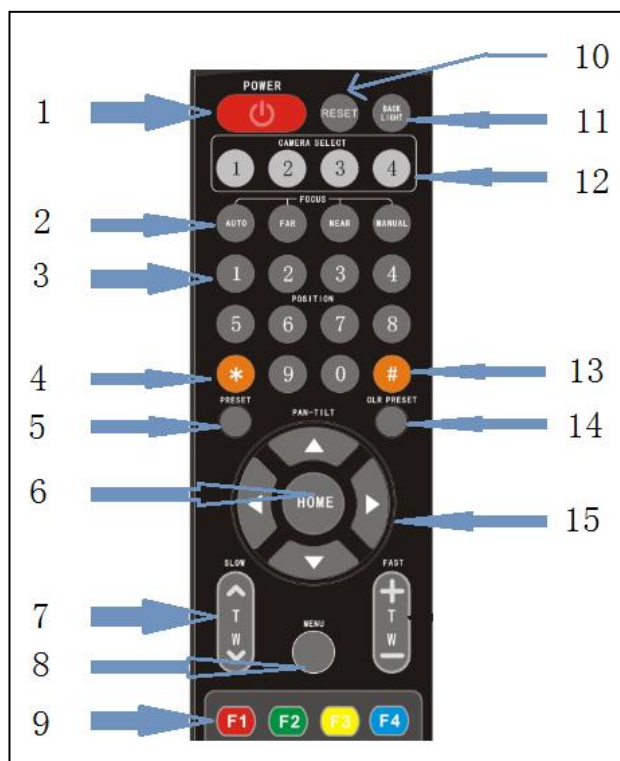

1. POWER Key

After press ,the camera will step into standby mode. Press again, the camera will self-test again and back to HOME position.

(Note: If power-on mode is turned on and Preset 0 is set, it will automatically point to the specified preset position.)

2. Focus Key

Auto focus:Enter into auto focus mode.

Manual focus:The camera focus mode is manual

Switch the camera focus mode to manual focus by pressing [focus +] or [focus -] to adjust.

3. POSITION Key

Set or run presets

4.* Key

Key combination use

5. PRESET Key

Set preset: PRESET + 0-9 number key:

Clear preset key:Clear preset key + 0-9 number key

6.HOME Key

“HOME” key: Return to the middle position.

7.Zoom Control key

SLOW: slow Zoom T: Lens near, zoom W: Lens far

FAST: fast Zoom+: Lens near, zoom -: Lens far

8. MENU Key

Open or close the OSD menu

Enter / exit the OSD menu or return to the previous menu.

9. Camera IR remote control address setting

【*】 + 【#】 + 【F1】 :Camera Address No.1

【*】 + 【#】 + 【F2】 :Camera Address No. 2

【*】 + 【#】 + 【F3】 :Camera Address No. 3

【*】 + 【#】 + 【F4】 :Camera Address No. 4

10.RESET Key

After press, camera will self-test.

11.BACK LIGHT Key

Back light compensation ON/OFF.

12. CAMERA SELECT

Choose the camera you need control

13. # Key

Key combination use

14.CLR PRESET Key

Clear preset key: CLR PRESET key + 0-9 number key

15. PAN-TILT Key

Press ▲key :Up

Press ▼key :Down

Press ◀key :Left

Press ▶key:Right

Key combination Functions

1) 【*】 + 【#】 + 【CLR PRESET】 :Clear all presets

2) 【*】 + 【#】 + 【6】 :Restore factory defaults

3) 【*】 + 【#】 + 【9】 :Flip switch

4) 【*】 + 【#】 + 【1】 : Menu set to English

5) 【*】 + 【#】 + 【3】 :Menu set to Chinese

Serial Communication Control

Under common working condition, the camera could be controlled through RS232/RS485 interface(VISCA, Pelco-D, Pelco-P),

➤ RS232C serial parameter are as follows

Baud rate: 2400/4800/9600 bits / sec;

Start bit: 1;

data bits: 8;

Stop bit: 1;

Parity: None.

➤ RS485 serial parameter are as follows

Baud rate: 2400/4800/9600 bits / sec;

Start bit: 1;

data bits: 8;

Stop bit: 1;

Parity: None.

After power on, the camera first go left, then back to the middle position. Self-test is finished after the zoom moved to the farthest and then back to the nearest position. If the camera saved 0 preset before, it will be back to that position after initialization. At this point, the user can control the camera by the serial commands.

Protocol list(Omitted)

Please contact manufacturer for the details of the protocol list if need secondary development.

MENU SETTING

1. Main menu

In normal working mode, press **【MENU】** key to display the menu, using scroll arrow to point at or highlight the selected items.

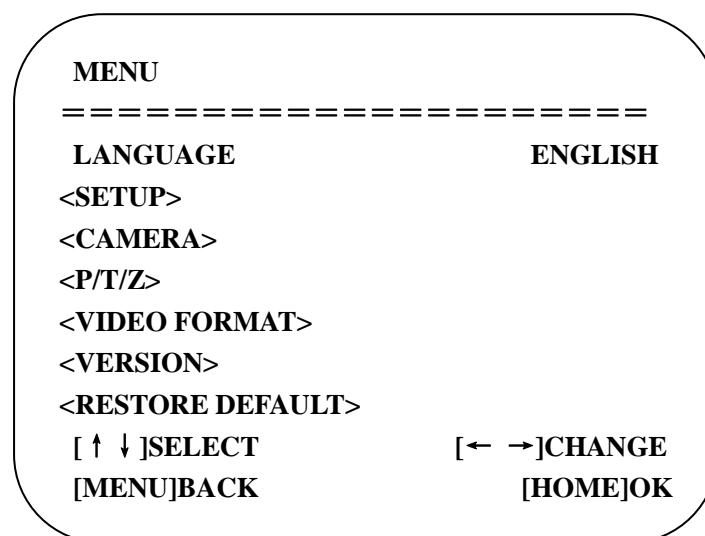

LANGUAGE: Language setting, Chinese / English

SETUP: System setting

CAMERA Option: Camera setting

PTZ Option: Pan tilt setting

VIDEO FORMAT: video format setting

VERSION: camera version setting

RESTORE DEFAULT: Reset setting

[↑↓] **SELECT:** for selecting menu

[← →] **CHANGE:** for modify parameters

[MENU] **BACK:** Press [MENU] to return

[HOME] **OK:** Press [Home] to confirm

2. System setting

Move the pointer to the (SETUP) in the Main Menu, click the **【HOME】** key and enter into the (SETUP) as shown below,

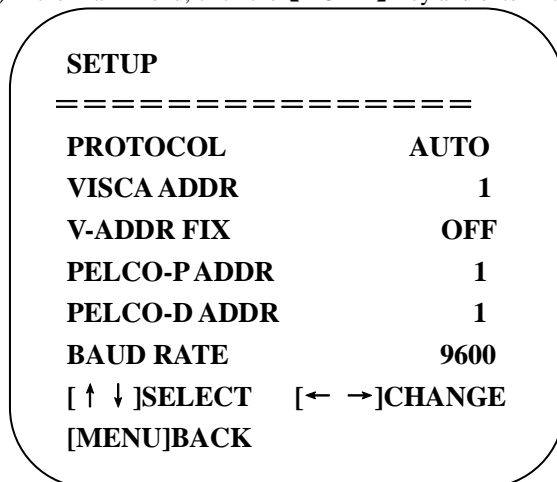

PROTOCOL: VISCA/ Pelco-P/ Pelco-D/ Auto

VISCA ADDR: VISCA=1~8 Pelco-P=1~16, Pelco-D =0~15

Baud rate: 2400/4800/9600/115200

VISCA ADDR FIX: On/Off

3. Camera setting

Move the pointer to the (CAMERA) in the Main Menu, click the **【HOME】** key and enter the (CAMERA) as follow,

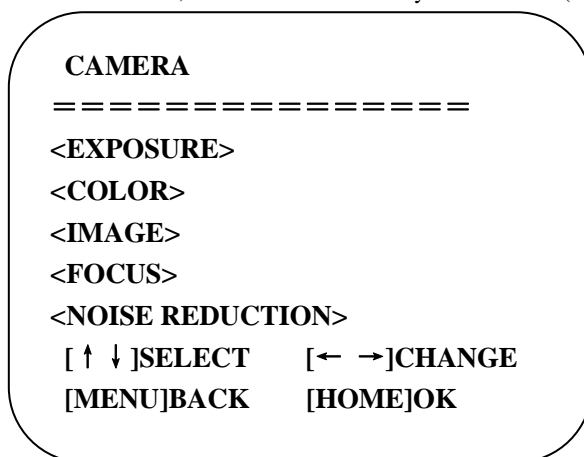

EXPOSURE: Enter into Exposure setting

COLOR: Enter into color setting

IMAGE: Enter into image setting

FOCUS: Enter into focus setting

NOISE REDUCTION: Enter into noise reduction

1) EXPOSURE SETTING

Move the pointer to the (EXPOSURE) in the Main Menu, click the **【HOME】** and enter the (EXPOSURE) as follow,

EXPOSURE

=====

BLC	OFF
WDR	5
[↑ ↓]SELECT	[← →]CHANGE
[MENU]BACK	

BLC: ON/OFF for options (only available in auto mode)

WDR: Off,1~8

2) COLOR SETTING

Move the pointer to the (COLOR) in the Main Menu, click the **【HOME】** and enter the (COLOR) as follow,

COLOR

=====

WB	AUTO
SATURATION	7
[↑ ↓]SELECT	[← →]CHANGE
[MENU]BACK	

WB: Auto, Indoor, Outdoor, Manual

SATURATION: 1~16

3) IMAGE

Move the pointer to the (IMAGE) in the Menu,click the **【HOME】** and enter the (IMAGE) as follow,

IMAGE

=====

BRIGHTNESS	6
CONTRAST	8
SHARPNESS	7
FLIP-H	OFF
FLIP-V	OFF
B/W MODE	DAY
DZOOM	OFF
[↑ ↓]SELECT	[← →]CHANGE
[MENU]BACK	

BRIGHTNESS: 0~14

CONTRAST: 0~14

SHARPNESS:0~15

FLIP-H: On/Off

FLIP-V: On/Off

B/W MODE: DAY/NIGHT

DZOOM: digital zoom options: On/Off

4) FOCUS

Move the pointer to the (FOCUS) in the Menu, click the **【HOME】** and enter the (FOCUS) as follow,

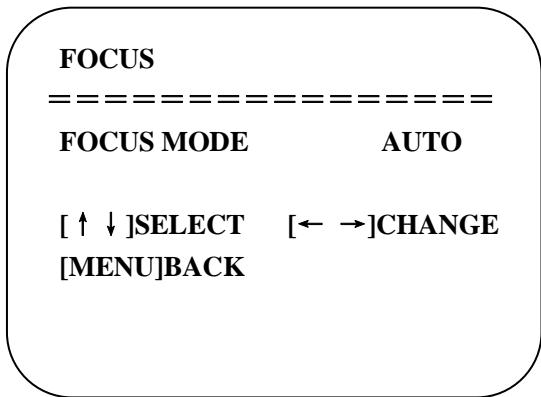

FOCUS MODE: Auto, manual

5) NOISE REDUCTION

Move the pointer to the (NOISE REDUCTION) in the Menu, click the **【HOME】** and enter the (NOISE REDUCTION) as follow,

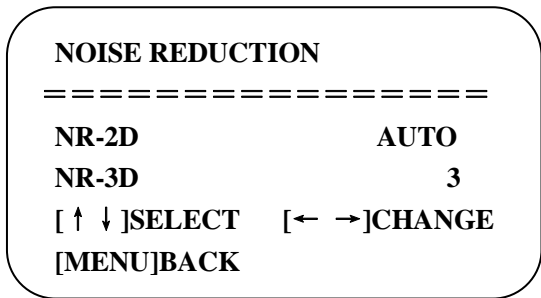

NR-2D: Auto,close,1~5

NR-3D: Close,1~8

4. P/T/Z

Move the pointer to the (P/T/Z) in the Main Menu, click the **【HOME】** and enter the (P/T/Z) as follow,

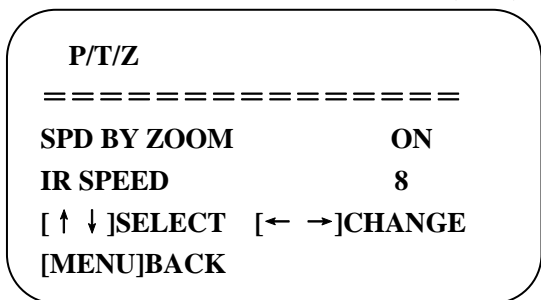

SPD BY ZOOM: Only effective for IR remote controller, On/ Off;
When zoom in, the PT control speed by remoter will become slow),

IR SPEED: Set the PTZ speed for remote controller,1~16

5. VIDEO FORMAT

Move the pointer to the (VIDEO FORMAT) in the Menu, click the **【HOME】** and enter the (VIDEO FORMAT) as follow,

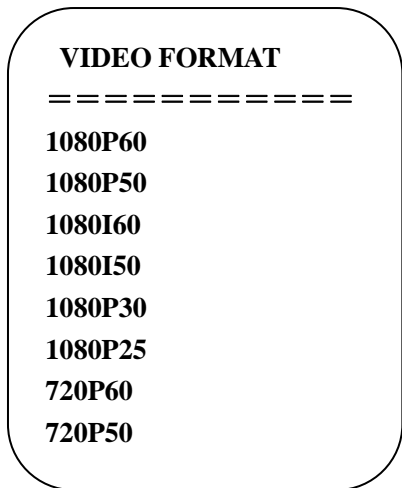

IP Camera Network Function

一. DeviceSearch quick start.

Device Name	Device Model	Channel Total	IP Address	Subnet Mask	Gateway	Data Port	Web Port	Multicast IP	Mu
11111111111111111111	IPCam CMOS Video Encoder*	1	192.168.55.77	255.255.255.0	192.168.55.1	5000	80	239.0.0.0	500
abcdefg	IPCam CMOS Video Encoder*	1	192.168.55.47	255.255.255.0	192.168.55.1	5000	80	239.0.0.0	500
IPC1000	HD Camcorder	1	192.168.1.42	255.255.255.0	192.168.1.1	5000	80	239.0.0.0	500
IPC112501	IPCam CMOS Video Encoder*	1	192.168.33.43	255.255.255.0	192.168.33.1	5000	80	239.0.0.0	500
IPC119990650	IPCam CMOS Video Encoder*	1	192.168.33.45	255.255.255.0	192.168.33.1	5000	80	239.0.0.0	500
IPC12222	Other model	1	192.168.55.130	255.255.255.0	192.168.55.1	5000	80	224.55.8.1	500
IPC130233	IPCam CMOS Video Encoder*	1	192.168.55.233	255.255.255.0	192.168.55.1	5000	80	239.0.0.0	500
IPC130341	IPCam CMOS Video Encoder*	1	192.168.55.41	255.255.255.0	192.168.55.1	5000	80	239.0.0.0	500
IPC130350	IPCam CMOS Video Encoder*	1	192.168.33.50	255.255.255.0	192.168.33.1	5000	80	239.0.0.0	500
IPC130352	IPCam CMOS Video Encoder*	1	192.168.33.52	255.255.255.0	192.168.33.1	5000	80	239.0.0.0	500
IPC130558	IPCam CMOS Video Encoder*	1	192.168.55.58	255.255.255.0	192.168.55.1	5000	80	239.0.0.0	500
IPC130561	IPCam CMOS Video Encoder*	1	192.168.55.61	255.255.255.0	192.168.55.1	5000	80	239.0.0.0	500
IPC139776280	IPCam CMOS Video Encoder*	1	192.168.1.40	255.255.255.0	192.168.1.1	5000	80	239.0.0.0	500
IPC20130555	IPCam CMOS Video Encoder*	1	192.168.55.55	255.255.255.0	192.168.55.1	5000	80	239.0.0.0	500
IPC33959208	IPCam CMOS Video Encoder*	1	192.168.55.52	255.255.255.0	192.168.55.1	5000	80	239.0.0.0	500
IPC355346	HD Camcorder	1	192.168.1.41	255.255.255.0	192.168.1.1	5000	80	239.0.0.0	500
IPC4001272	HD Camcorder	1	192.168.1.88	255.255.255.0	192.168.1.1	5000	80	239.0.0.0	500
IPC478961	IPCam CMOS Video Encoder*	1	192.168.55.239	255.255.255.0	192.168.55.1	5000	80	239.0.0.0	500
IPC80215927	IPCam CMOS Video Encoder*	1	192.168.55.88	255.255.255.0	192.168.55.1	5000	80	239.0.0.0	500
IPC71856851	HD Camcorder	1	192.168.1.44	255.255.255.0	192.168.1.1	5000	80	239.0.0.0	500
IPC921800	IPCam CMOS Video Encoder*	1	192.168.55.221	255.255.255.0	192.168.55.1	5000	80	239.0.0.0	500
IPC921809	IPCam CMOS Video Encoder*	1	192.168.33.44	255.255.255.0	192.168.33.1	5000	80	239.0.0.0	500
IPC921972	HD Camcorder	1	192.168.55.106	255.255.255.0	192.168.55.1	5000	80	239.0.0.0	500
IPC922676	HD Camcorder	1	192.168.55.38	255.255.255.0	192.168.55.1	5000	80	239.0.0.0	500
IPC923705	IPCam CMOS Video Encoder*	1	192.168.55.240	255.255.255.0	192.168.55.1	5000	80	239.0.0.0	500
IPC929712	IPCam CMOS Video Encoder*	1	192.168.55.10	255.255.255.0	192.168.55.1	5000	80	239.0.0.0	500
IPC929713	IPCam CMOS Video Encoder*	1	192.168.55.11	255.255.255.0	192.168.55.1	5000	80	239.0.0.0	500
IPC929714	IPCam CMOS Video Encoder*	1	192.168.55.12	255.255.255.0	192.168.55.1	5000	80	239.0.0.0	500
IPC929715	IPCam CMOS Video Encoder*	1	192.168.55.13	255.255.255.0	192.168.55.1	5000	80	239.0.0.0	500
IPC929716	IPCam CMOS Video Encoder*	1	192.168.55.14	255.255.255.0	192.168.55.1	5000	80	239.0.0.0	500
IPC97120002	IPCam CMOS Video Encoder*	1	192.168.1.45	255.255.255.0	192.168.1.1	5000	80	239.0.0.0	500

Local IP: 192.168.55.51

Search Set

Total: 31

1、Serch Devices

[Search]:click on the search button to search all coding equipment and related information in the local area network (LAN).

2、Change IP

[Set]:Select a device information, double-click or click "set", an interface will pop up to set up the equipment information as follow:

Network Parameter

Device type: HD IPCam

Device name: IPC351604

Channel num: 1

MAC: 00-5A-20-35-5E-75

IP address: 192 . 168 . 55 . 50

Subnet mask: 255 . 255 . 255 . 0

Gateway: 192 . 168 . 55 . 1

Data port: 5000

Web port: 80

Multicast IP: 224 . 55 . 55 . 1

Multicast port: 5000

DNS: 202 . 96 . 134 . 133

User name: admin

Password: admin

The device will reboot, when network parameters are modified.

OK Cancel

list1 points to the network parameter fields.

list2 points to the user name and password fields.

Setting equipment information of List1, user name and password must be filled correctly. Click [OK], the equipment will be restarted.

3.Back to search interface, double click the device need to visit, will pop to IE interface and visit the device.

二. IE Login

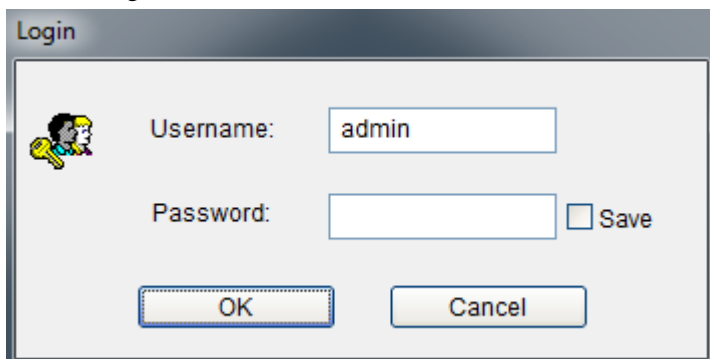

A login dialog box titled "Login" with a small cartoon character icon. It contains two input fields: "Username:" with the text "admin" and "Password:". To the right of the password field is a checkbox labeled "Save". At the bottom are two buttons: "OK" and "Cancel".

Default IP : 192.168.1.88

Default Username: admin

Default Password: admin

NOTE!

If user first time use this camera by internet (only for new user), must download and install widget. After installation, login again, will show as above:

After login again, the main interface of IP CAMERA will appear.

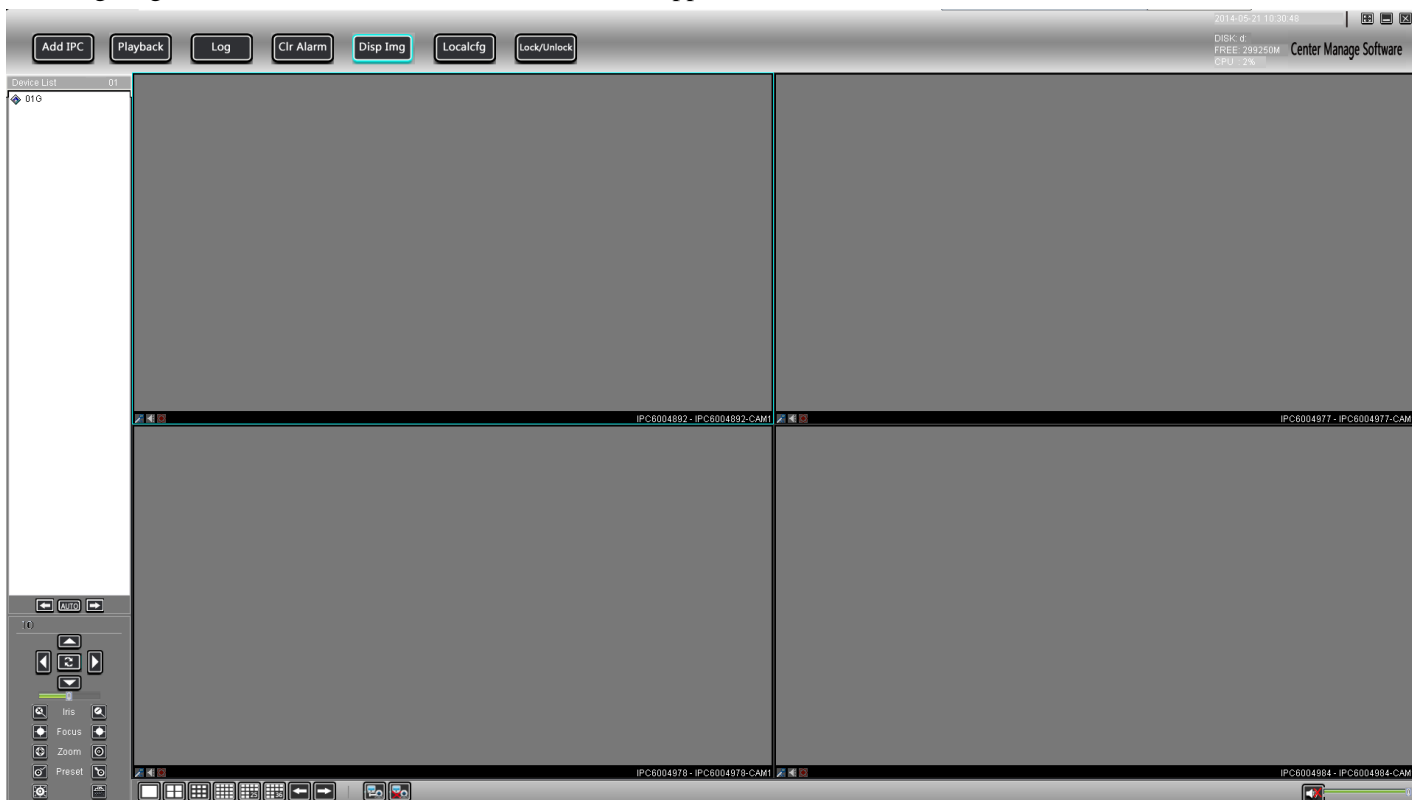

PTZ Control



Setting Interface, can change all the parameters of the IP Camera

Common	TCP/IP
Network	
TCP/IP	
Port	
DDNS	
FTP	
E-mail	
Port Mapping	
SNMP	
802.1x	
Video & Audio	
PTZ	
Image	
Events	
Storage	
System	
	IPv4
	IP Obtain Mode: Static IP
	IPv4 Address: 192.168.1.13
	Subnet Mask: 255.255.255.0
	Default Gateway: 192.168.1.1
	IPv6
	IPv6 Mode: Manual
	IPv6 Address:
	Prefix Length: 64
	Default Gateway:
	DNS
	Preferred DNS Server: 114.114.114.114
	Alternate DNS Server: 114.114.115.115
	MTU: 1500
	Port Type: FE Port
	Operating Mode: Auto-negotiation
	Save

Note:

Format for RTSP Stream:

rtsp://192.168.1.88:554/av0_0

av0_0 is main stream

av0_1 is sub-stream

Camera Maintenance and Troubleshooting

1. Camera Maintenance

- 1) If camera is not used for long time, please turn off power adapter switch and AC plug.
- 2) Use soft cloth or tissue to clean the camera cover.
- 3) Use soft cloth to clean the lens; Use neuter cleanser if bad smeared. No use strong or corrosive cleanser or corrosive cleanser avoiding scuffing.

2. Troubleshooting

1) No video output

- a, Check whether the camera power supply is connected, the voltage is normal, the power indicator is light on.
- b, Whether the machine could do self-inspection after restarted.
- c, Check whether the bottom of the DIP switch is the normal operating mode
- d, Check whether the video output cable or video display is normal

2) No image sometimes

- a, Check whether the video output cable or video display is in a normal state.

3) Image dithering when zoom-in or zoom-out

- a, Check whether the camera installation position is solid
- b, Whether there is shaking machine or objects around the camera

4) Remote controller cannot work

- a, Remote control address is set to 1 (if the machine is set back to the factory defaults, remote control addresses need to be back to 1 too)
- b, Check whether the battery is installed on the remote controller or low .
- c, Check the camera working mode is the normal operating mode
- d, Check the menu whether is closed, camera control through remote controller is only available after exiting the menu.

5) Serial port cannot work.

- a, Check whether the camera serial device protocol, baud rate, address is consistent
- b, Check whether the control cable is connected properly
- c, Check whether the camera working mode is the normal operating mode (see Table 1.2 and Table 1.3)

Copyright Notice:

All the contents of this manual and the copyright ownership belong to the company. Without the approval of the Company, no one can imitate, copy, reproduce or translate arbitrarily. This manual does not have any form of warranty, express or other imply. Specifications and information of this manual mentioned is just for informational purposes, and the content will be updated at any time without notice. Copyright cannot be reproduced.