

 **Prestel EHD3-4K100LU** HDBaseT 3.0 Extender with eARC/
ARC (100m)

Thank you for purchasing this product

For optimum performance and safety, please read these instructions carefully before connecting, operating or adjusting this product. Please keep this manual for future reference.

Surge protection device recommended

This product contains sensitive electrical components that may be damaged by electrical spikes, surges, electric shock, lightning strikes, etc. Use of surge protection systems is highly recommended in order to protect and extend the life of your equipment.

Table of Contents

1. Introduction.....	1
2. Features.....	1
3. Package Contents.....	1
4. Specifications.....	2
5. Operation Controls and Functions.....	4
5.1 Transmitter Panel.....	4
5.2 Receiver Panel.....	6
5.3 Input & Output Switching.....	7
5.4 Audio Embedding and De-embedding.....	9
5.5 USB Mode Applications.....	10
5.6 IR Pin Definition.....	11
6. Application Example.....	12

1. Introduction

This HDBaseT 3.0 Extender can extend uncompressed HD/UHD video and audio signals, eARC/ARC, RS-232, bi-directional IR, 1GbE Ethernet and USB2.0 signals up to 100m/328ft via a single CAT6A/7 cable. The Transmitter supports audio embedding or de-embedding. The Receiver supports audio de-embedding. It also supports eARC/ARC from RX's HDMI output pass through to TX's HDMI input or de-embedding to TX's HDMI audio only and SPDIF output ports, USB 2.0 (Host/Device is configurable) and bi-directional POC.

The Extender offers the most convenient solution for HDMI extension via a single CAT cable with long distance capability, and is the perfect solution for home/commercial application.

2. Features

- ☆ HDMI 2.0b, HDCP 2.2 and HDBaseT 3.0 compliant
- ☆ Uncompressed 4K@60Hz 4:4:4 up to 18Gbps video bandwidth
- ☆ HDR, HDR10, HDR10+, Dolby Vision and HLG pass through
- ☆ LPCM, Dolby Digital/Plus/EX, Dolby True HD, DTS, DTS-EX, DTS-96/24, DTS High Res, DTS-HD Master Audio, DSD pass through
- ☆ Transmission distance up to 328ft/100 meters via a single CAT 6A/7 cable
- ☆ Supports eARC/ARC function (the audio is returned to the HDMI IN port, HDMI OUT (AUDIO ONLY) port and SPDIF OUT port of the transmitter.)
- ☆ Supports SPDIF audio reverse transmission
- ☆ Bi-directional IR, RS-232 and 1G Ethernet signal pass through
- ☆ Supports USB2.0 transmission, Host/Device is configurable
- ☆ Bi-directional 24V POC function

3. Package Contents

- ① 1 x HDBaseT 3.0 Extender (Transmitter)
- ② 1 x HDBaseT 3.0 Extender (Receiver)
- ③ 1 x IR Blaster Cable (1.5 meters)
- ④ 1 x IR Receiver Cable (1.5 meters)
- ⑤ 2 x 3pin-3.81mm Phoenix Connectors
- ⑥ 4 x Mounting Ears
- ⑦ 8 x Machine Screws (KM3*4)
- ⑧ 1 x 24V/1A Locking Power Supply
- ⑨ 1x User Manual

4. Specifications

Technical	
HDMI Compliance	HDMI 2.0b
HDCP Compliance	HDCP 2.2
Video Bandwidth	18Gbps
Video Resolution	Up to 4K@60Hz 4:4:4
HDBaseT Bandwidth	16Gbps on main and 2Gbps on return link
HDR	HDR, HDR10, HDR10+, Dolby Vision, HLG
Color Space	RGB, YCbCr 4:4:4, YCbCr 4:2:2, YCbCr 4:2:0
Color Depth	8/10/12-bit
Audio Formats	LPCM, Dolby Digital/Plus/EX, Dolby True HD, DTS, DTS-EX, DTS-96/24, DTS High Res, DTS-HD Master Audio, DSD
L/R Audio Formats	PCM 2.0
SPDIF Audio Formats	LPCM2.0, AC3 5.1, DTS 5.1
IR Level	12Vp-p
IR Bandwidth	20K - 60KHz
USB Bandwidth	Up to 350Mbps
Ethernet	1000Mbps
RS-232	Up to 921600bps
Transmission Distance	100m (via a single CAT 6A/7 cable)
ESD Protection	Human body model — ±8kV (Air-gap discharge) & ±4kV (Contact discharge)
Connection	
Transmitter	Input: 1 x HDMI IN [Type A, 19-pin female] Output: 1 x HDMI OUT [Type A, 19-pin female] 1 x HDBT OUT [RJ45, 8-pin female] 1 x SPDIF OUT [S/PDIF] 1 x L/R OUT [3.5mm Stereo Mini-jack] Control: 1 x IR IN [3.5mm Stereo Mini-jack] 1 x IR OUT [3.5mm Stereo Mini-jack] 1 x RS-232 [3pin-3.81mm Phoenix jack] 1 x SERVICE [Mini-USB, Update port] 1 x USB HOST [USB Type B] 2 x USB DEVICES [USB Type A] 1 x LAN [RJ45]

Receiver	Input: 1 x HDBT IN [RJ45, 8-pin female] 1 x SPDIF IN [S/PDIF] Output: 1 x HDMI OUT [Type A, 19-pin female] 1 x L/R OUT [3.5mm Stereo Mini-jack] Control: 1 x IR IN [3.5mm Stereo Mini-jack] 1 x IR OUT [3.5mm Stereo Mini-jack] 1 x RS-232 [3pin-3.81mm Phoenix jack] 1 x SERVICE [Mini-USB, Update port] 1 x USB HOST [USB Type B] 2 x USB DEVICES [USB Type A] 1 x LAN [RJ45]		
Mechanical			
Housing	Metal Enclosure		
Color	Black		
Dimensions	Transmitter / Receiver: 170mm [W] x 102mm [D] x 22mm [H]		
Weight	Transmitter: 425g, Receiver: 437g		
Power Supply	Input: AC 100 - 240V 50/60Hz Output: DC 24V/1A (US/EU standard, CE/FCC/UL certified)		
Power Consumption	15.36W (POC)		
Operating Temperature	32 - 104°F / 0 - 40°C		
Storage Temperature	-4 - 140°F / -20 - 60°C		
Relative Humidity	20 - 90% RH (no condensation)		
Resolution / Cable Length	4K60 - Feet / Meters	4K30 - Feet / Meters	1080P60 - Feet / Meters
HDMI IN / OUT	16ft / 5M	32ft / 10M	50ft / 15M
The use of "Premium High Speed HDMI" cable is highly recommended.			

5. Operation Controls and Functions

5.1 Transmitter Panel

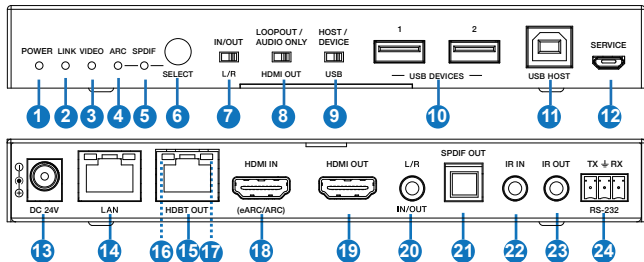

No.	Name	Function Description
1	Power LED	Red LED indicates that the Transmitter is powered on.
2	LINK LED	<ul style="list-style-type: none">Light on: Transmitter and Receiver are in good connection status.Light flashing: Transmitter and Receiver are in Low Power Mode.Light off: Transmitter and Receiver are not connected.
3	VIDEO LED	<ul style="list-style-type: none">Light on: The video is encrypted.Light flashing: The video is not encrypted.Light off: No HDMI input.
4	ARC LED	<ul style="list-style-type: none">Light on: The device is switched to the ARC mode.Light off: The device is switched to the SPDIF mode.
5	SPDIF LED	<ul style="list-style-type: none">Light on: The device is switched to the SPDIF mode.Light off: The device is switched to the ARC mode.
6	SELECT button	Used for switching the ARC mode and SPDIF mode.
7	L/R IN/OUT switch	Switch to left, the L/R IN/OUT port is the audio embedding port; Switch to right, the L/R IN/OUT port is the audio de-embedding port.
8	LOOP OUT / AUDIO ONLY switch	Switch to left (LOOP OUT), the HDMI OUT port is the loopout port for the HDMI IN port; Switch to right (AUDIO ONLY), the HDMI OUT port outputs 720P black screen image, and the audio is from ARC or SPDIF.

9	HOST/ DEVICE USB switch	Switch to left (HOST), the USB HOST mode is enabled; Switch to right (DEVICE), the USB DEVICE mode is enabled.
10	USB DEVICES	Two USB device ports, connected to U disk, mouse or keyboard.
11	USB HOST	USB extension host port, connected to PC.
12	SERVICE	Firmware update port.
13	DC 24V	DC 24V/1A power supply input port. <i>Note that the extender supports POC function, it means that either transmitter or receiver is powered on by 24V/1A power adapter, the other one doesn't need power supply.</i>
14	LAN	1G Network port. When it switches to Gigabit Ethernet, the green indicator lights on; When it switches to 100M Ethernet, the yellow indicator lights on.
15	HDBT OUT	10G Network port, connected to the HDBT IN port of Receiver with a CAT 6A/7 cable. It is used for various signals pass-through.
16	Data Signal Indicator (Yellow)	<ul style="list-style-type: none"> ▪ Illuminating: HDMI signal with HDCP. ▪ Flashing: HDMI signal without HDCP. ▪ Dark: No HDMI signal.
17	Link Signal Indicator (Green)	<ul style="list-style-type: none"> ▪ Illuminating: Transmitter and Receiver are in good connection status. ▪ Flashing: Transmitter and Receiver are in poor connection status. ▪ Dark: Transmitter and Receiver are not connected.
18	HDMI IN	HDMI signal input port, connected to signal source device, supporting eARC/ARC amplifier.
19	HDMI OUT	HDMI signal loopout port. It can choose to be a LOOP OUT or AUDIO ONLY port through the LOOP OUT/AUDIO ONLY switch.
20	L/R IN/OUT	Audio embedding/de-embedding port. It can be used for audio embedding/de-embedding through the L/R IN/OUT switch.
21	SPDIF OUT	Optical output port.
22	IR IN	IR signal input port, connected to IR Receiver cable.
23	IR OUT	IR signal output port, connected to IR Blaster cable.
24	RS-232	RS-232 serial port, used for serial port command transmission.

5.2 Receiver Panel

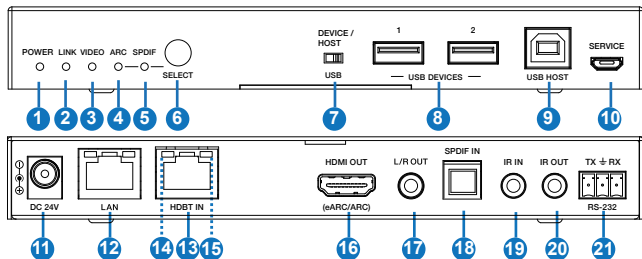

No.	Name	Function Description
1	Power LED	Red LED indicates that the Receiver is powered on.
2	LINK LED	<ul style="list-style-type: none"> Light on: Transmitter and Receiver are in good connection status. Light flashing: Transmitter and Receiver are in Low Power Mode. Light off: Transmitter and Receiver are not connected.
3	VIDEO LED	<ul style="list-style-type: none"> Light on: The video is encrypted. Light flashing: The video is not encrypted. Light off: No HDMI input.
4	ARC LED	<ul style="list-style-type: none"> Light on: The device is switched to the ARC mode. Light off: The device is switched to the SPDIF mode.
5	SPDIF LED	<ul style="list-style-type: none"> Light on: The device is switched to the SPDIF mode. Light off: The device is switched to the ARC mode.
6	SELECT button	Used for switching the ARC mode and SPDIF mode.
7	DEVICE/ HOST USB switch	Switch to right (HOST), the USB HOST mode is enabled; Switch to left (DEVICE), the USB DEVICE mode is enabled.
8	USB DEVICES	Two USB device ports, connected to U disk, mouse or keyboard.
9	USB HOST	USB extension host port, connected to PC.
10	SERVICE	Firmware update port.
11	DC 24V	DC 24V/1A power supply input port. <i>Note that the extender supports POC function, it means that either transmitter or receiver is powered on by 24V/1A power adapter, the other one doesn't need power supply.</i>

12	LAN	1G Network port. When it switches to Gigabit Ethernet, the green indicator lights on; When it switches to 100M Ethernet, the yellow indicator lights on.
13	HDBT IN	10G Network port, connected to the HDBT OUT port of Transmitter with a CAT 6A/7 cable. It is used for various signals pass-through.
14	Data Signal Indicator (Yellow)	<ul style="list-style-type: none"> ▪ Illuminating: HDMI signal with HDCP. ▪ Flashing: HDMI signal without HDCP. ▪ Dark: No HDMI signal.
15	Link Signal Indicator (Green)	<ul style="list-style-type: none"> ▪ Illuminating: Transmitter and Receiver are in good connection status. ▪ Flashing: Transmitter and Receiver are in poor connection status. ▪ Dark: Transmitter and Receiver are not connected.
16	HDMI OUT	HDMI signal output port, supporting eARC/ARC TV.
17	L/R OUT	Audio de-embedding output port.
18	SPDIF IN	Optical input port.
19	IR IN	IR signal input port, connected to IR Receiver cable.
20	IR OUT	IR signal output port, connected to IR Blaster cable.
21	RS-232	RS-232 serial port, used for serial port command transmission.

5.3 Input & Output Switching

The Extender can switch to ARC/SPDIF mode by pressing the SELECT button on the front panel of both transmitter and receiver. The HDMI OUT port of the transmitter can turn to LOOP OUT or AUDIO ONLY through the LOOP OUT/AUDIO ONLY switch. The input and output routing are different for different scenarios, as shown in the diagrams below:

Scene 1: Set the Extender to SPDIF Mode. Then switch the LOOP OUT/AUDIO ONLY switch to right, the HDMI OUT port of the transmitter is set to AUDIO ONLY.

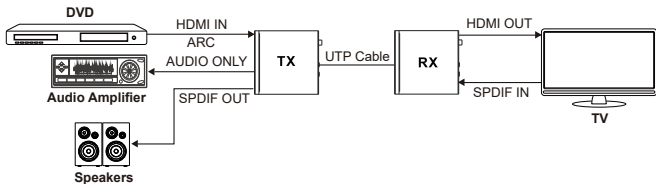

Scene 2: Set the Extender to SPDIF Mode. Then switch the LOOP OUT/AUDIO ONLY switch to left, the HDMI OUT port of the transmitter is set to LOOP OUT.

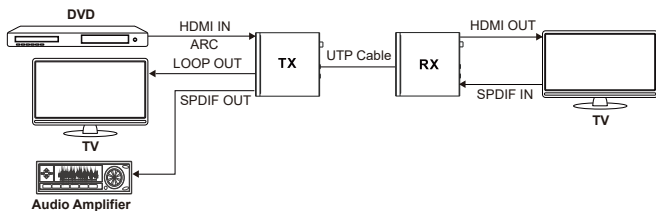

Scene 3: Set the Extender to ARC Mode. Then switch the LOOP OUT/AUDIO ONLY switch to right, the HDMI OUT port of the transmitter is set to AUDIO ONLY.

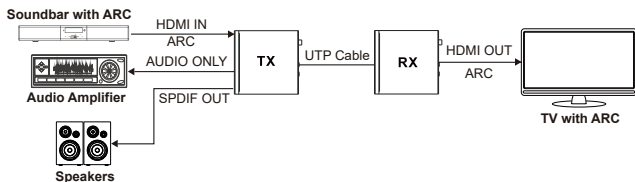

Scene 4: Set the Extender to ARC Mode. Then switch the LOOP OUT/AUDIO ONLY switch to left, the HDMI OUT port of the transmitter is set to LOOP OUT.

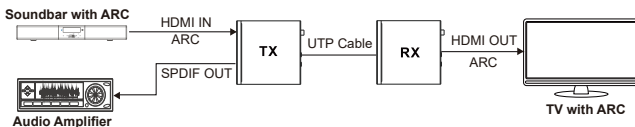

Scene 5: Set the Extender to eARC Mode. Then switch the LOOP OUT/AUDIO ONLY switch to right, the HDMI OUT port of the transmitter is set to AUDIO ONLY.

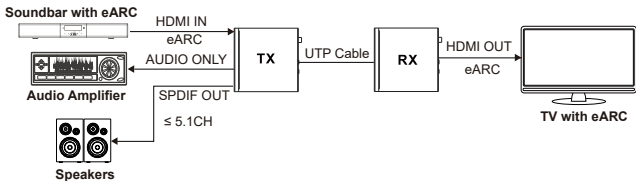

Scene 6: Set the Extender to eARC Mode. Then switch the LOOP OUT/AUDIO ONLY switch to left, the HDMI OUT port of the transmitter is set to LOOP OUT.

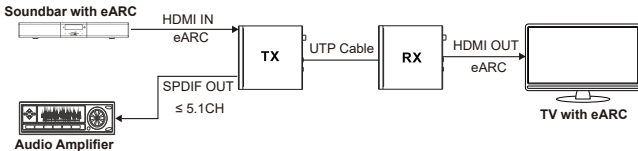

Note: In eARC mode, the SPDIF OUT port can only output the audio up to 5.1CH.

5.4 Audio Embedding and De-embedding

The Transmitter supports audio embedding and de-embedding. The L/R IN/OUT port can be used for audio embedding or de-embedding through the L/R IN/OUT switch.

▪ TX Audio Embedding

When the L/R IN/OUT switch is switched to left, the audio from external audio device will be embedded to the L/R IN/OUT port.

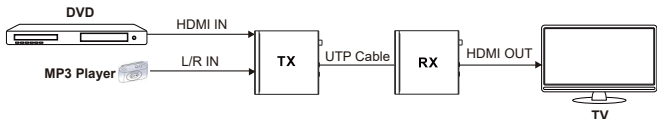

▪ TX Audio De-embedding

When the L/R IN/OUT switch is switched to right, The L/R IN/OUT port will output the audio de-embedded from the HDMI IN port.

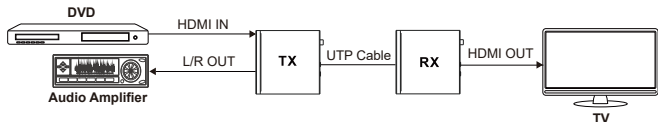

5.5 USB Mode Applications

The Extender supports USB2.0 transmission, and Host/Device is configurable.

Mode 1: USB forward from TX to RX

Switch the HOST/DEVICE USB switch to left, then power off and reboot the transmitter to set to USB Host mode. Meanwhile, switch the DEVICE/HOST USB switch to left, then power off and reboot the receiver to set to USB Device mode.

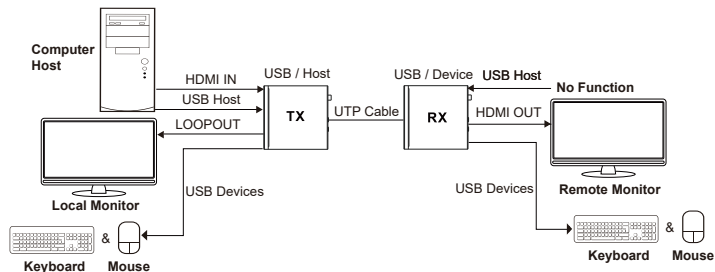

Mode 2: USB reverse from RX to TX

Switch the HOST/DEVICE USB switch to right, then power off and reboot the transmitter to set to USB Device mode. Meanwhile, switch the DEVICE/HOST USB switch to right, then power off and reboot the receiver to set to USB Host mode.

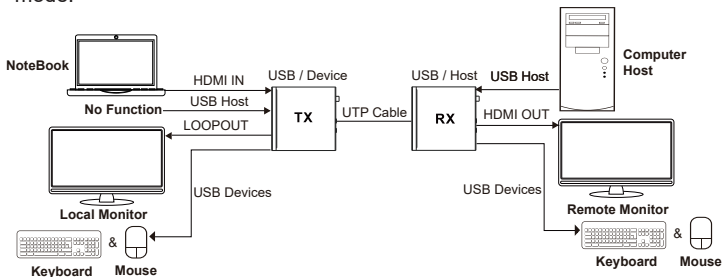

5.6 IR Pin Definition

IR Receiver and Blaster pin's definition as below:

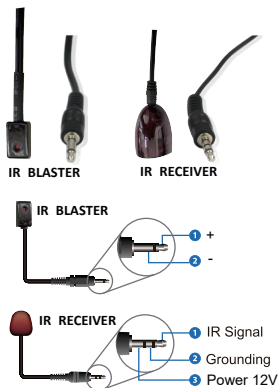

Note: When the angle between the IR receiver and the remote control is $\pm 45^\circ$, the transmission distance is 0-5 meters; when the angle between the IR receiver and the remote control is $\pm 90^\circ$, the transmission distance is 0-8 meters.

6. Application Example

Transmitter

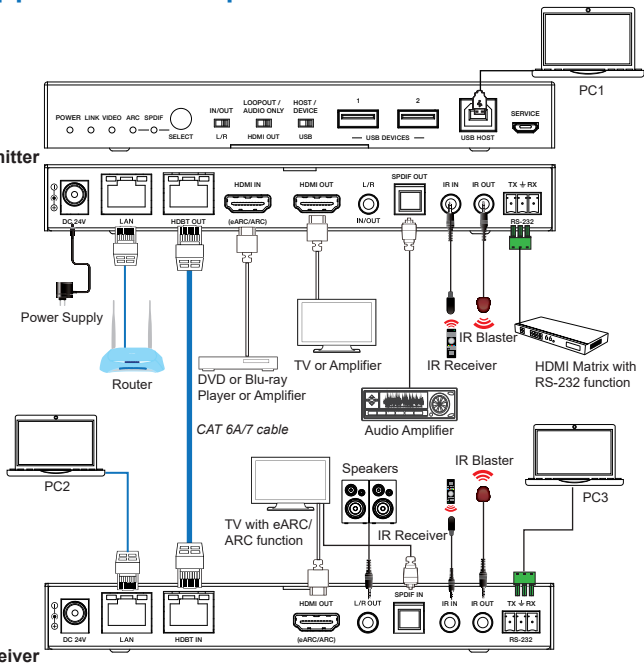

Receiver