

Auto Framing 4K EPTZ Camera Prestel 4K-F4U3 User Manual (V1.0)

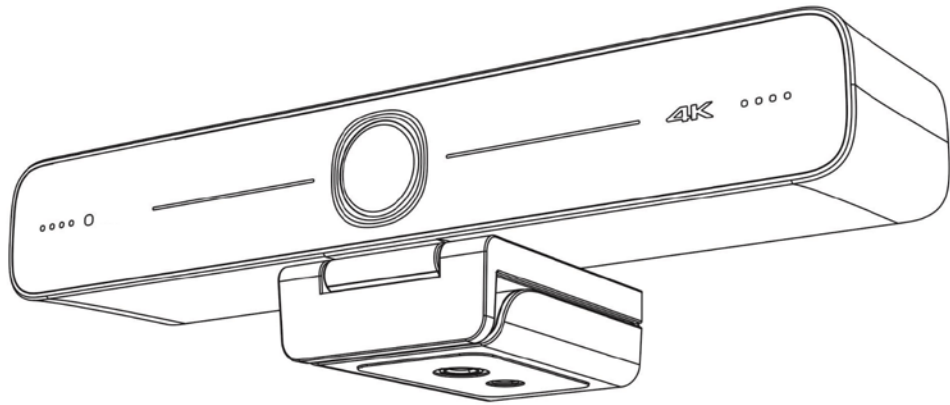

Attentions

This manual introduces functions, installations and operations for this camera in details. Please read this manual carefully before installation and use.

1. Cautions

- 1.1 Avoid damage to product caused by heavy pressure, strong vibration or immersion during transportation, storage and installation.
- 1.2 Housing of this product is made of organic materials. Do not expose it to any liquid, gas or solids which may corrode the shell.
- 1.3 Do not expose the product to rain or moisture.
- 1.4 To prevent the risk of electric shock, do not open the case. Installation and maintenance should only be carried out by qualified technicians.
- 1.5 Do not use the product beyond the specified temperature, humidity or power supply specifications.
- 1.6 Wipe it with a soft, dry cloth when cleaning the camera lens. Wipe it gently with a mild detergent if needed. Do not use strong or corrosive detergents to avoid scratching the lens and affecting the image.
- 1.7 This product contains no parts which can be maintained by users themselves. Any damage caused by dismantling the product by user without permission is not covered by warranty.

2. Electrical Safety

Installation and use of this product must strictly comply with local electrical safety standards.

3. Install

- 3.1 Do not rotate the camera head violently, otherwise it may cause mechanical failure;
- 3.2 This product should be placed on a stable desktop or other horizontal surface. Do not install the product obliquely, otherwise it may display inclined image.
- 3.3 Ensure there are no obstacles within rotation range of the holder.
- 3.4 Do not power on before completely installation.

4. Magnetic Interference

Electromagnetic fields at specific frequencies may affect the video image. This product is Class A. It may cause radio interference in household application. Appropriate measure is required.

Content

1.Camera Installation.....	3
1.1 Camera Interfaces.....	3
1.2 Camera Operation.....	3
2.Product Overview.....	3
2.1 Product Introduction.....	3
2.1.1 Model.....	3
2.1.2 Dimension.....	3
2.1.3 Accessory.....	4
2.2 Main Features.....	4
2.3 Technical Parameter.....	5
2.4 Interfaces Instruction.....	6
2.4.1 External Interface.....	6
3.Application Instruction.....	7
3.1 Remote Control.....	7
3.1.1 Keys Introduction.....	7
3.1.2 Applications.....	7
3.2 Menu Introduction.....	9
3.2.1 Main Menu.....	9
4. Maintenance and Troubleshooting.....	14
4.1 Camera Maintenance.....	14
4.2 Troubleshooting.....	14
5. Copyright Statement.....	14

1.Camera Installation

1.1 Camera Interfaces

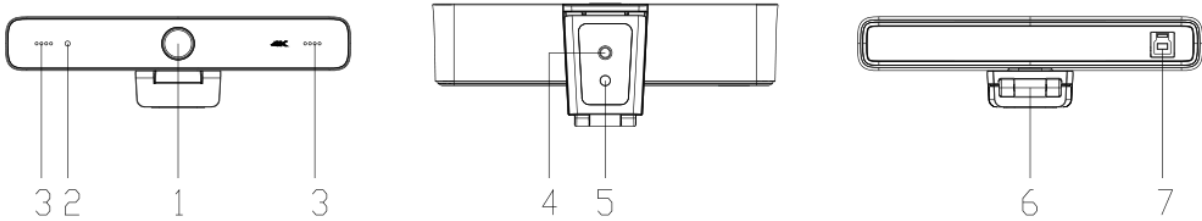

Figure 1.1 Product Interfaces

- 1.Camera Lens
- 2.Indicator light
- 3.Built-in MIC

- 4.Tripod fixing hole
- 5.Positioning hole
- 6.Bracket

- 7.USB3.0 interface

1.2 Camera Operation

- 1) Product Installation: Fix the device on LCD screen, top of computer; directly put it on desk or on tripod mounting.
- 2) Connect camera via USB cable to computer, video conference terminal or other USB input device, log in the video conference software and select a video device to have image output.

2.Product Overview

2.1 Product Introduction

2.1.1 Model



Figure 2.1 Product Model

2.1.2 Dimension

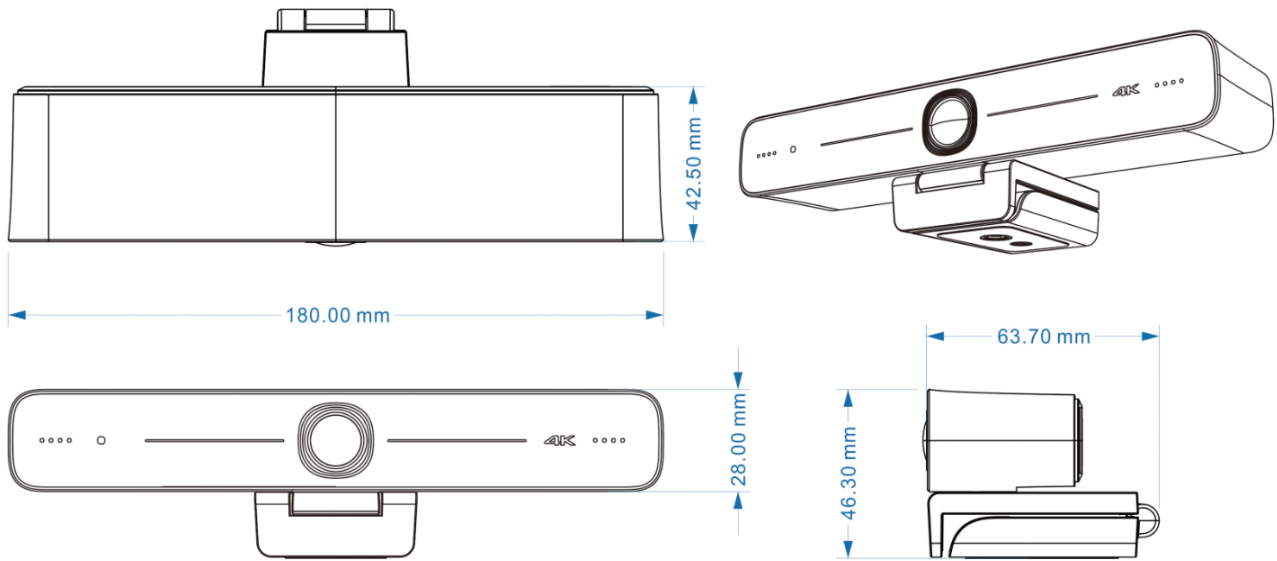

Figure 2.2 Product Dimension

2.1.3 Accessory

Please check below standard and optional accessories when unpacking the box.

Standard Accessory	IR Remote Control
	USB3.0 Cable
	User Manual

2.2 Main Features

4K-F4U3 is a 4K ultra-high-definition ePTZ camera with a new design. With AI intelligence, it can frames according to the number of people in the scene, and the characters are in the middle. It has perfect functions and superior performance, which employs advanced ISP processing algorithms so as to provide vivid images with evenly clear brightness, strong color layering, high resolution, and fantastic color rendition. Easy and convenient to install and maintain, stable and reliable.

- **Ultra HD 4K Resolution:** 1/2.8 inch high quality CMOS sensor. Resolution is up to 4K with frame rate up to 30fps (MJPG) or 30fps (H.264); compatible with 1080P and 720P.
- **ePTZ:** ePTZ and 10X digital Zoom;
- **Built-in MIC:** Built-in two omni-directional MIC pickups; with unique noise suppression algorithm, effective pickup distance up to 6 meters.

- **Auto Framing:** Employing superior face detection algorithm to intelligently and automatically frames according to the number of people in the scene, and the characters are in the middle.
- **Wide FOV:** 83° wide angle and small distortion lens options.
- Video output interface: Video output interface USB 3.0;
- **Multiple Audio/Video Compression Standard:** Supports H.264, MJPG, YUY2, NV12 video compression, to made video play smoothly.
- **Low Noise and High SNR:** Super high SNR image is achieved with low noise CMOS. Even in the case of ultra-low illumination, the picture remains clean and clear.
- **Multiple Installations:** Standard equipped with mold clamp. Easy to install on any devices, such as LCD screen, laptop, table and tripod.
- **Easy to Use:** No need to download driver; USB 3.0 Plug and play;
- **Wide Applications:** Personal video conferencing, enterprise video conferencing, collaboration meeting, etc.

2.3 Technical Parameter

Model	
Camera Parameter	
Sensor	1/2.8 inch high quality 4K CMOS sensor
Effective Pixels	8.28MP,16: 9
Video Interface	1 Channel USB 3.0 output, Type B; Support audio signal output
Audio input	2*Built-in MIC pickup
Video Format	MJPG: 3840*2160@30 /2560*1440@30 /1920*1080@30 /1600*896@30 /1280*720@30 /1024*576@30 /960*540@30 /800*600@30 /800*448@30 /720*576@30 /720*480@30 /640*480@30 /640*360@30 /480*270@30 /352*288@30 /320*240@30 H264: 3840*2160@30 /2560*1440@30 /1920*1080@30 /1600*896@30 /1280*720@30 /1024*576@30 /960*540@30 /800*600@30 /800*448@30 /720*576@30 /720*480@30 /640*480@30 /640*360@30 /480*270@30 /352*288@30 /320*240@30 YUY2: 1920*1080@30 /1280*720@30 /1024*576@30 /800*600@30 /800*448@30 /640*480@30 /640*360@30 /480*270@30 /320*180@30 NV12: 1920*1080@15 /1280*720@30 /1024*576@30 /800*600@30 /800*448@30 /640*480@30 /640*360@30 /480*270@30 /320*180@30
View Angle	91° (D) /83°(H)/54°(V)
Focal Length	f=3.24mm
Aperture	F2.1
Digital Zoom	10X
Minimum Illumination	0.1Lux(F1.8, AGC ON)
White Balance	Auto / Manual
Focus	Manual
Exposure	Auto / Manual/
BLC	On/Off
SNR	≥50dB

USB Feature	
Operation Systems	Windows 7(1080p or lower), Windows 8.1, Windows 10 ; macOS™ 10.10 or higher; Android; Linux (UVC support)
Video Compression Format	YUY2,NV12,MJPG,H264
USB Audio	Support
USB Communication Protocol	UVC,UAC
PTZ Control	Support EPTZ

Hardware Requirement	2.4 GHz Intel@ Core 2 Duo or higher, 2GB or higher, USB 3.0 port (USB 3.0 for 4K)
-----------------------------	---

Other Parameter	
Input Voltage	5V
Input Current	1A(max)
Power Consumption	5W(max)
Stored Temperature	-10°C~+60°C
Stored Humidity	20%~90%
Working Temperature	-10°C~+50°C
Working Humidity	20%~80%
Dimension	180mm×42.5mm×46.3mm
Weight	Around 0.3kg
Working Environment	Indoor
Accessory	User Manual, USB 3.0 cable

2.4 Interfaces Instruction

2.4.1 External Interface

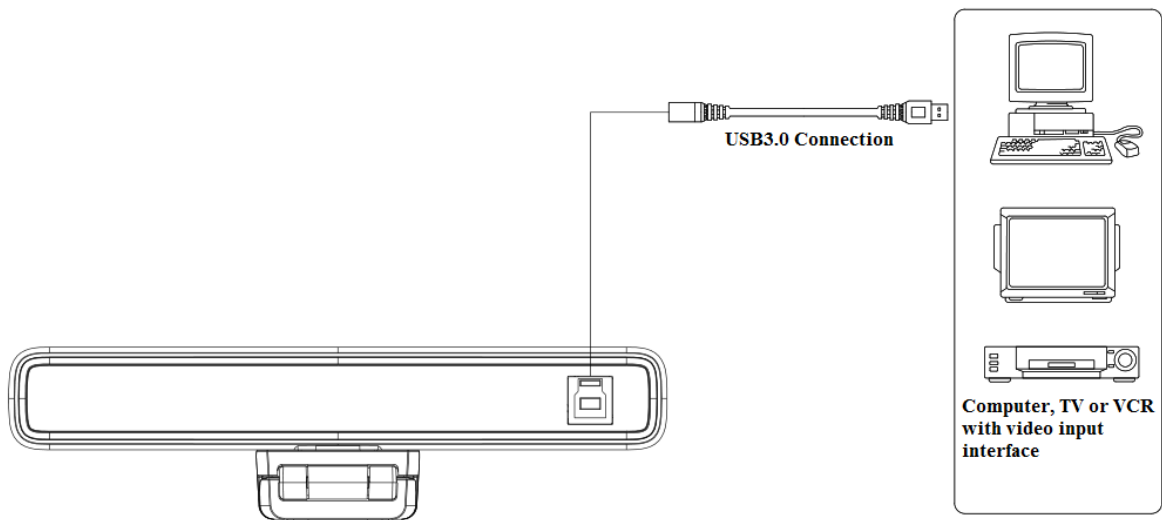

Figure 2.4 Wiring Diagram

3.Application Instruction

3.1 Remote Control

3.1.1 Keys Introduction

1.Standby Key

The device enters standby mode after pressing it once, and the device re-displays the picture after pressing it again.

2.Camera Selection

Select the camera address to control.

3. Number key

Set or call 0-9 presets

4. 【*】 , 【#】 key

5.Focus Control

【Auto】 : None 【Manual】 : None

Note: The camera is a fixed focus lens

6.Zoom Control

ZOOM +: press 【ZOOM +】 key to zoom in

ZOOM -: press 【ZOOM -】 key to zoom out

7.Set and Clear Presets

Set Preset: press 【SET PRESET】 button, and then press the number key 0-9 to set preset positions.

Clear Preset: press 【CLEAR PRESET】 button, and then press the number key 0-9 to clear preset positions.

8.Pan/Tilt Control

Up: press ▲ Down: press ▼

Left: press ◀ Right: press ▶

Press and hold the up/down/left/right key, the pan/tilt movements will keep running.

【HOME】 : Camera lens back to the middle position; Enter next menu

9. 【BLC ON/OFF】 : Turn on or off the back light compensation

10.Menu Setting: Enter/exit the OSD menu or return to the previous menu.

11.Camera Remote Control Address Setting

【*】 + 【#】 + 【F1】 : Camera Address No.1

【*】 + 【#】 + 【F2】 : Camera Address No.2

【*】 + 【#】 + 【F3】 : Camera Address No.3

【*】 + 【#】 + 【F4】 : Camera Address No.4

12.Key Combination

1) 【#】 + 【#】 + 【#】 : Clear all presets

3) 【*】 + 【#】 + 【9】 : Flip switch

5) 【*】 + 【#】 + 【3】 : Menu set to Chinese

2) 【*】 + 【#】 + 【6】 : Restore factory defaults

4) 【*】 + 【#】 + 【4】 : Menu set to English



3.1.2 Applications

1) In this manual, “press the key” means a click rather than a long-press, and a special note will be given if a long-press for more than one second is required.

2) When a key-combination is required, do it in sequence. For example, “【*】+【#】+【F1】” means press “【*】” first and then press “【#】” and last press “【F1】”.





1) Camera Selection



Select the camera address to control.

2) Pan/Tilt Control



Up: press  Down: press 
 Left: press  Right: press 
 Back to middle position: press “【HOME】”

Press and hold the up/down/left/right key, the pan/tilt movements will keep running, from slow to fast, until it runs to the endpoint; stop as soon as the key is released.

3) Set and Clear Presets



Save Preset: press 【SET PRESET】 button, and then press the number key 0-9 to set preset positions.

Note: 10 presets via remote control.

Call Preset: Press a number key 0-9 directly to call a preset position.

Note: If the number key is not preset, it is invalid.

Clear Preset: press 【CLEAR PRESET】 button, and then press the number key 0-9 to clear preset positions.

Note: press the 【#】 key three times continually to clear all presets.



4) Zoom Control

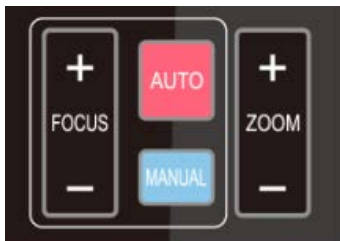

ZOOM +: press 【ZOOM +】 key to zoom in
 ZOOM -: press 【ZOOM -】 key to zoom out
 Press and hold the keys, the action of focus will keep continue and stop as soon as the key is released.

5) Focus Control

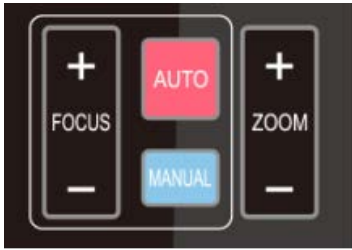

Focus + (near): Press **【 FOCUS + 】** None
 Focus - (far): Press **【 FOCUS - 】** None
 Auto focus: not supported
 Manual focus: not supported

6) Camera Remote Control Address Setting

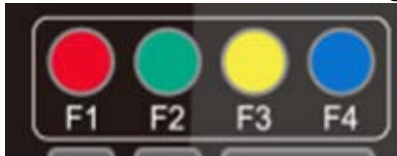

【 * 】 + 【 # 】 + 【 F1 】 :Camera Address No.1
【 * 】 + 【 # 】 + 【 F2 】 :Camera Address No.2
【 * 】 + 【 # 】 + 【 F3 】 :Camera Address No.3
【 * 】 + 【 # 】 + 【 F4 】 :Camera Address No.4

3.2 Menu Introduction

3.2.1 Main Menu

Press **【 MENU 】** key under **MJPEG, YUY2, NV12 or H264 compression encoding format output** to display the menu, using scroll arrow to point at or highlight the selected items.

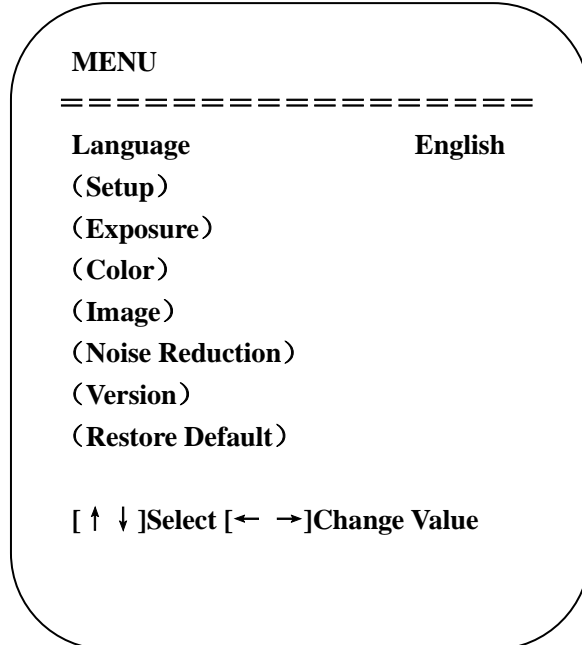

1) Language

1. Language Setting: press **【 ← → 】** key to select Language

2) System Setting

Move the pointer to the (Setup) in the Main Menu, click the **【HOME】** key and enter into the (System Setting) as shown below,

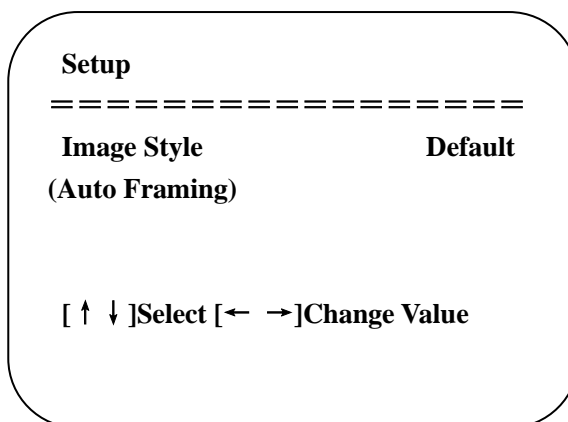
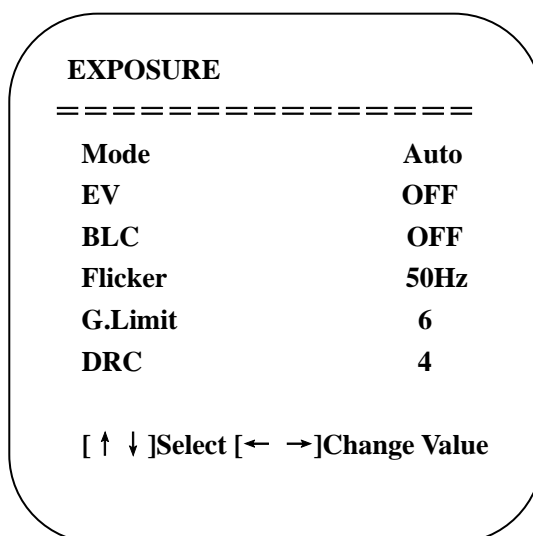

Image Style: default / standard / clear / bright / soft can be set

Intelligent zoom: on / off

3) Exposure Setting

Move the pointer to EXPOSURE in the Main Menu, click the **【HOME】** and enter the (EXPOSURE SET) as follows:



Mode: Auto, Manual, Shutter priority and Brightness priority.

EV: On/Off (only available in auto mode)

Compensation Level: -7~7 (only available in auto mode when EV is ON)

BLC: ON/OFF for options (only available in auto mode)

Anti-Flicker: OFF/50Hz/60Hz for options (only available in Auto/Iris priority/Brightness priority modes)

Gain limit: 0~15(only available in Auto/ Iris priority /Brightness priority mode)

WDR: Off, 1~8

ShutterPriority:1/30,1/50,1/60,1/90,1/100,1/120,1/180,1/250,1/350,1/500,1/1000,1/2000,1/3000,1/4000,1/6000, 1/10000 (only available in Manual and Shutter priority mode)

Brightness: 0~23 (only available in Brightness priority mode)

4) Color

Move the pointer to the (COLOR) in the Main Menu, click the **【HOME】** and enter the (COLOR sub menu) as follow,

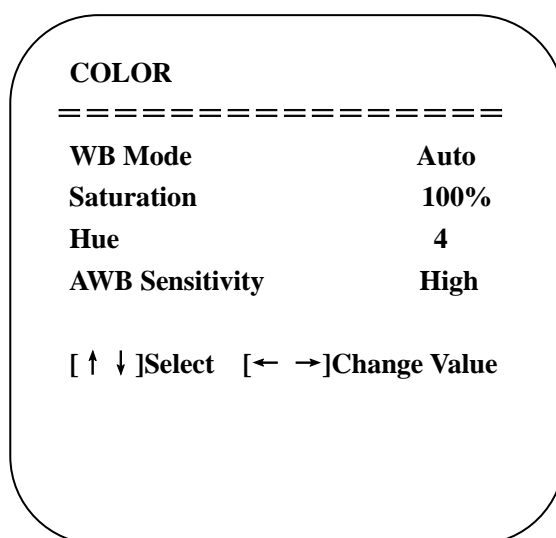

WB Mode: Auto, Manual, One Push, Specified color temperature

Saturation: 60%,70%,80%,90%,100%,110%,120%,130%,140%,150%,160%,170%,180%,190%,200%

AWB Sensitivity: high/middle/low(only available in automatic mode)

Chroma: 0~8

5) Image

Move the pointer to the (IMAGE) in the Menu, click the **【HOME】** and enter into the (IMAGE sub menu) as follow,

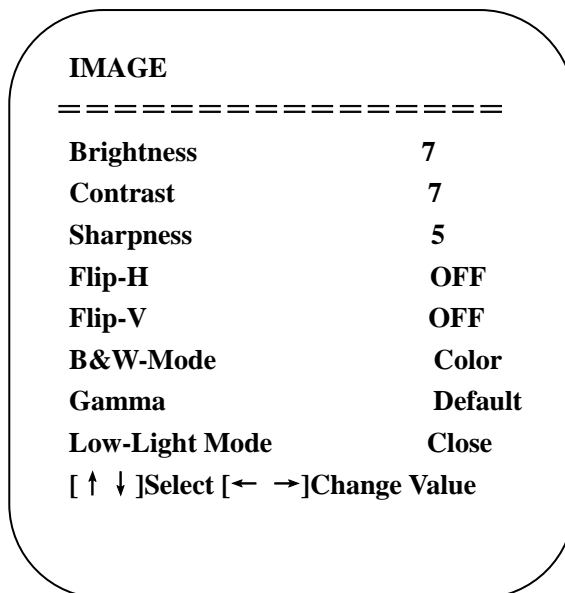

Brightness: 0~14

Contrast: 0~14

Sharpness: 0~15

Flip-H: On/Off

Flip-V: On/Off

B&W Mode: color, black/white

Gamma: Default/0.34/0.39/0.47/0.5

Minimum Illumination: On/Off

6) Noise Reduction

Move the pointer to the (NOISE REDUCTION) in the Menu, click the **【HOME】** and enter the (NOISE REDUCTION) as follow,

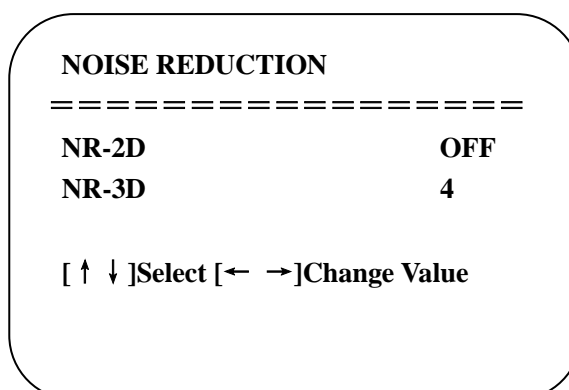

2D Noise Reduction: Auto, close, 1~7

3D Noise Reduction: Close, 1~8

7) Version

Move the pointer to the (VERSION) in the Main Menu, click the **【HOME】** and enter the (VERSION) as follow,

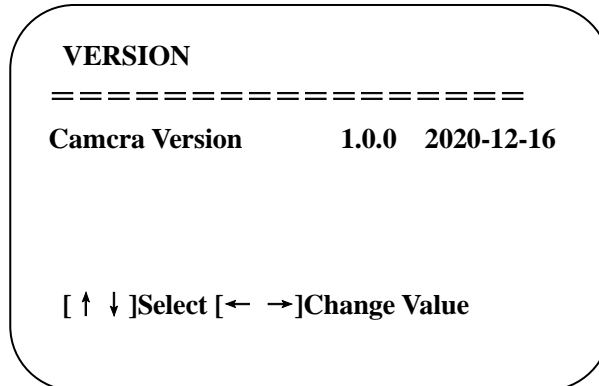

8) Restore Default

Move the pointer to the (RESTORE DEFAULT) in the Main Menu, click the **【HOME】** and enter the (RESTORE DEFAULT) as follow,

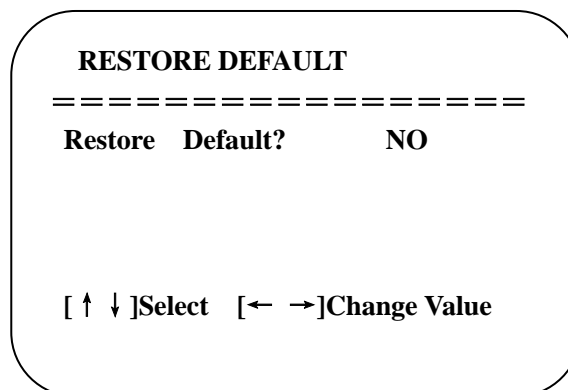

Restore default: YES/NO. Color style and video format cannot be restored to factory default

Note: If the address of former remoter is not 1 but another one from 2, 3, 4, the corresponding camera address will restore to 1 when all parameters or system parameters are restored. User should change the remoter address to be 1 (press No.1 according to the camera so to get normal operation)

4. Maintenance and Troubleshooting

4.1 Camera Maintenance

- 1) Please power off the camera and disconnect the power adapter and socket, if it's not used for a long run.
- 2) Use soft cloth or tissue to clean the camera cover.
- 3) Wipe it with a soft, dry cloth when cleaning the camera lens. Wipe it gently with a mild detergent if needed. Do not use strong or corrosive detergents to avoid scratching the lens and affecting the video quality.

4.2 Troubleshooting

1)No video output

- a. Check whether USB cable connected well and power indicator light is ON.
- b. Whether the machine could do self-check after restarted.
- c. Restart the computer to check whether it is normal
- d. Check whether the video output cable or video display is normal
- f. Check whether the camera is well recognized by PC

2)No image sometimes

- a. Check the USB cable quality and whether connected well.

5. Copyright Statement

All the contents in this manual and its copyright are owned by the company. No one is allowed to imitate, copy, or translate this manual without the company's permission. This manual contains no guarantee, standpoint expression or other implies in any form. Product specification and information in this manual is for reference only and subject to change without notice.

All rights reserved. No reproducing is allowed without acknowledgement.